



ENGLISH

User manual



TABLE OF CONTENTS

1. PRECAUTIONS AND SAFETY MEASURES	2
1.1. Preliminary instructions	3
1.2. During use	3
1.3. After use	3
1.4. Definition of Measurement (Overvoltage) category	4
2. GENERAL DESCRIPTION	5
2.1. Measuring average values and TRMS values	5
3. PREPARATION FOR USE	6
3.1. Initial checks	6
3.2. Instrument power supply	6
3.3. Storage	6
4. NOMENCLATURE	7
4.1. Description of the instrument	7
4.2. Description of function keys	9
4.2.1. Key HOLD/REL	9
4.2.2. Key RANGE	9
4.2.3. Key MODE/VFD	9
4.2.4. Key IR/  (ECLIPSE), Key  (HT9025)	9
4.2.5. Key  /INRUSH	9
4.3. Description of internal functions	10
4.3.1. Description of the display, Multimeter section	10
4.3.2. Description of the display, Thermal camera section (ECLIPSE)	11
4.3.3. AC+DC current and voltage measurement	11
4.3.4. Storage of measurement results	12
4.3.5. Relative measurement	12
4.3.6. MIN/MAX and PEAK measurement	13
4.3.7. Detection of AC voltage without contact	13
4.3.8. Measurement of AC, AC+DC Voltage with low impedance (LoZ)	14
4.3.9. Measurement of Voltage or Current on VFD devices	14
4.3.10. General menu of the instrument	15
5. OPERATING INSTRUCTIONS	21
5.1. DC voltage measurement	21
5.2. AC, AC+DC, VFD voltage measurement	22
5.3. LoZAC, LOZAC+DC voltage measurement	23
5.4. Frequency and Duty Cycle measurement	24
5.5. Resistance measurement and continuity test	25
5.6. Diode test	26
5.7. Capacitance measurement	27
5.8. Temperature measurement with K-type probe	28
5.9. DC current measurement	29
5.10. AC current measurement	30
5.11. Inrush current measurement	31
5.12. Measurement of DC, AC, AC+DC current with clamp transducers	32
5.13. Data Logger function	33
5.14. Use of the internal thermal camera (ECLIPSE)	37
5.15. Bluetooth connection and use of the APP HTMercury	39
6. MAINTENANCE	40
6.1. Recharging the internal battery	40
6.2. Cleaning the instrument	40
6.3. End of life	40
7. TECHNICAL SPECIFICATIONS	41
8. ACCESSORIES	45
9. ASSISTANCE	46
9.1. Warranty conditions	46
9.2. Assistance	46

1. PRECAUTIONS AND SAFETY MEASURES

The instrument has been designed in compliance with directive IEC/EN61010-1 relevant to electronic measuring instruments. For your safety and in order to prevent damaging the instrument, please carefully follow the procedures described in this manual and read all notes preceded by symbol  with the utmost attention. Before and after carrying out measurements, carefully observe the following instructions:

CAUTION



- Do not carry out any measurements in case gas, explosive materials or flammables are present, or in humid or dusty environments.
- Do not carry out any measurement in case you find anomalies in the instrument such as deformation, breaks, substance leaks, absence of display on the screen, etc.
- Avoid any contact with the circuit being measured if no measurements are being carried out.
- Avoid contact with exposed metal parts, with unused measuring probes, circuits, etc.
- Pay special attention when measuring voltages higher than 20V, since a risk of electrical shock exists
- Keep the instrument steady during any measuring operation.
- Do not carry out any measurements which exceed the working and storage temperature ranges specified in § 7
- Only the accessories provided together with the instrument will guarantee safety standards. They must be used only if in good conditions and replaced with identical models, when necessary.
- Check that the battery is correctly inserted.
- Check that the LCD display gives indications consistent with the function selected.
- Do not direct the instrument at very high intensity radiation sources (e.g. the sun) in order to prevent damaging the IR sensor.
- Prevent hits or strong vibrations in order to keep the instrument from damage.
- When bringing the instrument from a cold to a hot environment, leave it on long enough for condensation water to evaporate.

In this manual, and on the instrument, the following symbols are used:



Warning: observe the instructions given in this manual; improper use could damage the instrument or its components.



High voltage danger: electrical shock hazard.



This symbol indicates that the clamp can operate on live conductors



Double-insulated meter



AC voltage or current



DC voltage or current



Connection to earth



This symbol on the display means that the instrument (ECLIPSE) is able to emit a laser pointer in Class 2. **Do not direct the radiation towards the eyes in order to prevent physical damage to people.**

1.1. PRELIMINARY INSTRUCTIONS

- This instrument has been designed for use in environments of pollution degree 2.
- It can be used for **VOLTAGE** and **CURRENT** measurements on installations with CAT IV 600V and CAT III 1000V
- We recommend following the normal safety rules devised by the procedures for carrying out operations on live systems and using the prescribed PPE to protect the user against dangerous currents and the instrument against incorrect use.
- In case the lack of indication of the presence of voltage may represent a danger for the operator, always carry out a continuity measurement before carrying out the measurement on the live system, in order to confirm the correct connection and condition of the leads.
- Only the leads supplied with the instrument guarantee compliance with the safety standards. They must be in good conditions and be replaced with identical models, when necessary.
- Do not test circuits exceeding the specified voltage limits.
- Do not perform any test under environmental conditions exceeding the limits indicated in § 0
- Check that the battery is correctly inserted.
- Make sure that the LCD display and the rotary switch indicate the same function.

1.2. DURING USE

Please carefully read the following recommendations and instructions:



CAUTION

Failure to comply with the caution notes and/or instructions may damage the instrument and/or its components or be a source of danger for the operator.

- Before activating the rotary switch, disconnect the test leads from the circuit being measured.
- When the instrument is connected to the circuit being measured, do not touch any unused terminal.
- Do not measure resistance in case external voltages are present; even if the instrument is protected, an excessive voltage may cause malfunction.
- While measuring, if the value or the sign of the quantity being measured remain unchanged, check if the HOLD function is enabled.

1.3. AFTER USE

- When measurement is complete, set the rotary switch to OFF to switch off the instrument.
- If the instrument is not to be used for a long time, remove the battery.

1.4. DEFINITION OF MEASUREMENT (OVERVOLTAGE) CATEGORY

Standard "IEC/EN61010-1: Safety requirements for electrical equipment for measurement, control and laboratory use, Part 1: General requirements", defines what measurement category, commonly called overvoltage category, is. § 6.7.4: Measured circuits, reads:

(OMISSIS)

Circuits are divided into the following measurement categories:

- **Measurement category IV** is for measurements performed at the source of the low-voltage installation.
Examples are electricity meters and measurements on primary overcurrent protection devices and ripple control units.
- **Measurement category III** is for measurements performed on installations inside buildings.
Examples are measurements on distribution boards, circuit breakers, wiring, including cables, bus-bars, junction boxes, switches, socket-outlets in the fixed installation, and equipment for industrial use and some other equipment, for example, stationary motors with permanent connection to fixed installation.
- **Measurement category II** is for measurements performed on circuits directly connected to the low-voltage installation.
Examples are measurements on household appliances, portable tools and similar equipment.
- **Measurement category I** is for measurements performed on circuits not directly connected to MAINS.
Examples are measurements on circuits not derived from MAINS, and specially protected (internal) MAINS-derived circuits. In the latter case, transient stresses are variable; for that reason, the standard requires that the transient withstand capability of the equipment is made known to the user.

2. GENERAL DESCRIPTION

The instrument has the following features:

Multimeter function

- DC Voltage up to 1500V
- AC, AC+DC TRMS Voltage
- DC, AC, AC+DC TRMS Voltage with low impedance (LoZ)
- AC TRMS Voltage and Current on VFD devices
- DC, AC TRMS Current with jaws
- DC, AC, AC+DC TRMS Current with external clamp transducer
- AC TRMS Inrush Current
- Resistance and Continuity test
- Diode test
- Capacity
- Frequency
- Duty Cycle
- Temperature with K-type probe
- Data Logger function and display of graphs of measured data
- Storage of BMP images on internal memory

Thermal camera function (ECLIPSE)

- Infrared temperature measurement ranging from -20°C to 260°C
- 3 measuring cursors (central steady + hot spot + cold spot)
- Emissivity of materials which can be selected between 0.01 and 1.00
- Image frequency: 50Hz
- 5 selectable color palettes
- Automatic detection of hot/cold spots of the image
- Storage of BMP images on external micro SD card
- IR sensor resolution: 80x80pxl
- Built-in laser pointer and illuminator

Each of these functions can be selected by means of the appropriate switch. The instrument is also equipped with function keys (see § 4.2), analogue bargraph and LCD TFT high-contrast color display. The instrument is also equipped with an Auto Power OFF function which automatically switches off the instrument after a certain (programmable) idling time.

2.1. MEASURING AVERAGE VALUES AND TRMS VALUES

Measuring instruments of alternating quantities are divided into two big families:

- AVERAGE-VALUE meters: instruments measuring the value of the sole wave at fundamental frequency (50 or 60 Hz).
- TRMS (True Root Mean Square) VALUE meters: instruments measuring the TRMS value of the quantity being tested.

With a perfectly sinusoidal wave, the two families of instruments provide identical results. With distorted waves, instead, the readings shall differ. Average-value meters provide the RMS value of the sole fundamental wave; TRMS meters, instead, provide the RMS value of the whole wave, including harmonics (within the instruments bandwidth). Therefore, by measuring the same quantity with instruments from both families, the values obtained are identical only if the wave is perfectly sinusoidal. In case it is distorted, TRMS meters shall provide higher values than the values read by average-value meters.

3. PREPARATION FOR USE

3.1. INITIAL CHECKS

Before shipping, the instrument has been checked from an electric as well as mechanical point of view. All possible precautions have been taken so that the instrument is delivered undamaged. However, we recommend generally checking the instrument in order to detect possible damage suffered during transport. In case anomalies are found, immediately contact the forwarding agent. We also recommend checking that the packaging contains all components indicated in § 8. In case of discrepancy, please contact the Dealer. In case the instrument should be returned, please follow the instructions given in § 9

3.2. INSTRUMENT POWER SUPPLY

The instrument is powered by 1x7.4V rechargeable Li-ION battery included in the package. When the battery is flat, the symbol "□" appears on the display. For battery recharge, please refer to § 6.1.

3.3. STORAGE

In order to guarantee precise measurement, after a long storage time, wait for the instrument to come back to normal condition (see § 7).

4. NOMENCLATURE

4.1. DESCRIPTION OF THE INSTRUMENT



CAPTION:

1. Inductive clamp jaw
2. DC Current positive polarity
3. AC Voltage NCV detector
4. Jaw trigger
5. LCD display
6. Key **MODE/VFD**
7. Key **HOLD/REL**
8. Key **INRUSH**
9. Key **RANGE**
10. Key **IR/** (ECLIPSE)
Key **IR/** (HT9025)
11. Rotary selector switch
12. Input terminal **COM**
13. Input terminal

Fig. 1: Description of the instrument's front

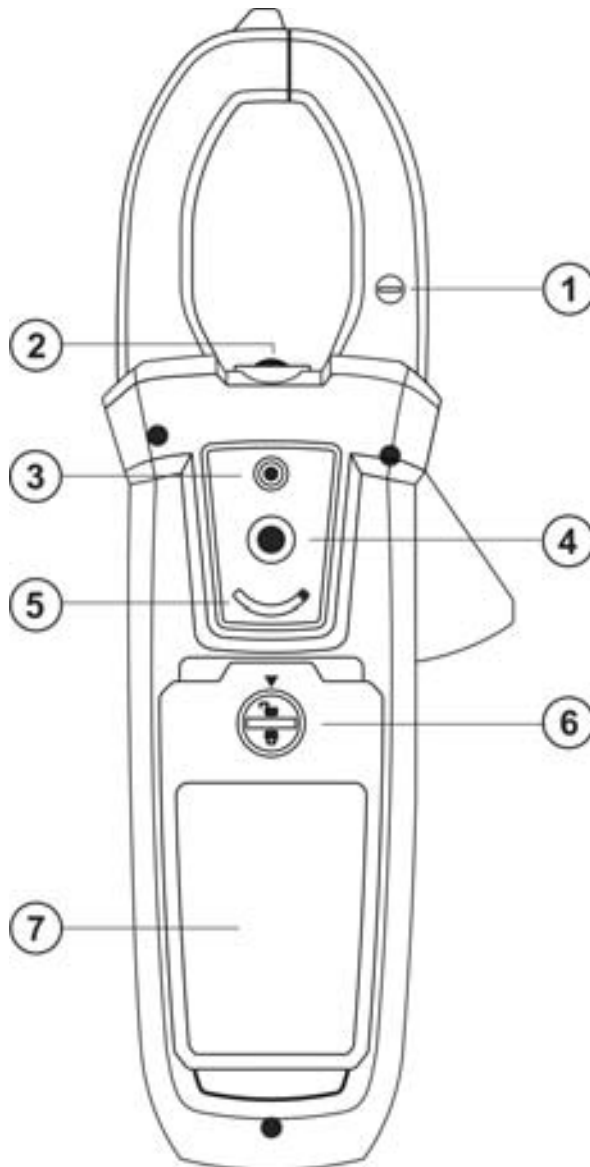

CAPTION:

1. DC Current negative polarity
2. White LED illuminator
3. Laser pointer (ECLIPSE)
4. Thermal camera lens (ECLIPSE)
5. Lens protection selector (ECLIPSE)
6. Battery cover fastening screw
7. Battery cover

Fig. 2: Description of the instrument's back

Put the conductor within the jaws on intersection of the indicated marks as much as possible (see Fig. 2) in order to meet the meter accuracy specifications)

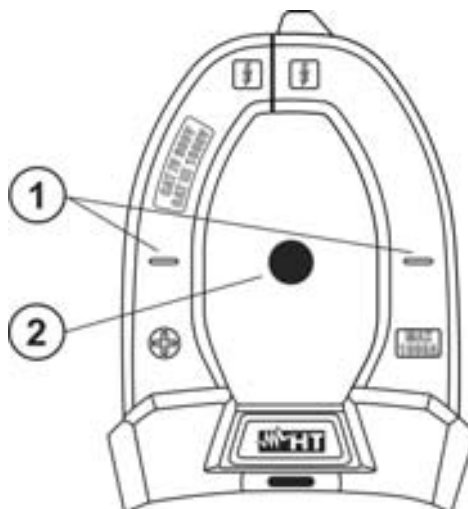

CAPTION:

1. Alignment marks
2. Conductor

Fig. 3: Alignment marks

4.2. DESCRIPTION OF FUNCTION KEYS

4.2.1. Key HOLD/REL

Pressing key **HOLD/REL** freezes the value of the measured quantity on the display. After pressing this key, the message "HOLD" appears on the display. Press the key **HOLD/REL** again to quit the function. To save the value on the display, see § 4.3.4. Key **HOLD/REL** also allows quitting the programming menu, going back to the instrument's main measuring screen and restores the display's illumination with instrument in Auto Power OFF mode. Press longer the **HOLD/REL** key in order to activate/deactivate the relative measurement on the selected function (see § 4.3.5).

4.2.2. Key RANGE

Press key **RANGE** to activate manual mode and disable the Autorange function. The symbol "Manual Range" appears on the display. In manual mode, press key **RANGE** to change measuring range: the relevant decimal point will change its position and the full scale value in the bargraph will change too. Key **RANGE** is not active in positions \blacktriangleright , $\cdot\cdot\cdot$), Type K and $60A\sim$, $600A\sim$, $1000A\sim$. In Autorange mode, the instrument selects the most appropriate ratio for carrying out measurement. If a reading is higher than the maximum measurable value, the indication "OL" appears on the display. Press and hold key **RANGE** for more than 1 second to exit the manual mode and restore the Autorange mode.

4.2.3. Key MODE/VFD

Pressing key **MODE** allows selecting a double function on the rotary switch. In particular, it is active in position $\Omega\text{CAP}\blacktriangleright\cdot\cdot\cdot$) for the selection of measurements for diode test, continuity test, capacity test and measurement of resistance, in position TypeK for the selection of temperature measurement in °C, °F or K, $\text{Hz}\%$ for the selection of frequency measurement and duty cycle, $\text{VAC+DC}\sim$ for the selection of measurements "mV \equiv " and "V \equiv (AC+DC)" (see § 4.3.3), $\text{V}\sim\text{Hz}\%$ for the selection of AC voltage measurement, AC voltage frequency and duty cycle of AC voltage, LoZAC+DC for the selection of AC voltage with low impedance measurement (see § 4.3.8) "V \sim " and "V \equiv (AC+DC)", $60A\sim$, $600A\sim$, $1000A\sim$

for the selection of AC and DC current measurement for the selection of AC, DC and $A\equiv$ (AC+DC) current measurement. In position TypeK , pressing and holding (>2s) key **MODE/VFD** allows selecting the type of clamp, Standard (TypeK) or Flexible (TypeK). In the positions $\text{VAC+DC}\sim$, $60A\sim$, $600A\sim$, $1000A\sim$ the longer press (>2s) of **MODE/VFD** key allows to activate/deactivate the **VFD (Variable Frequency Driver)** measurement mode (see § 4.3.9) in order to evaluate the AC voltage and current downstream variable frequency drivers (inverters)

4.2.4. Key IR/ ECLIPSE , Key HT9025

Pressing key **IR/ ECLIPSE** allows displaying the multimeter section or the combination multimeter + thermographic image (see § 5.14). Pressing and holding (>2s) key **IR/ ECLIPSE** or pressing key HT9025 allows turning on/off the internal white LED illuminator (see Fig. 2 – part 2).

4.2.5. Key INRUSH

Key **INRUSH** , given by the combination of keys INRUSH and $\blacktriangle, \blacktriangleright, \blacktriangledown, \blacktriangleleft$, allows entering the instrument's programming section in order to set both system parameters and those connected to the detection of the thermographic image (see § 4.3.10). In the positions $60A\sim$, $600A\sim$, $1000A\sim$ the longer press (>2s) of the **INRUSH** key allows to activate/deactivate the AC inrush current of electrical machines with 100ms response time (see § 5.11).

4.3. DESCRIPTION OF INTERNAL FUNCTIONS

4.3.1. Description of the display, Multimeter section

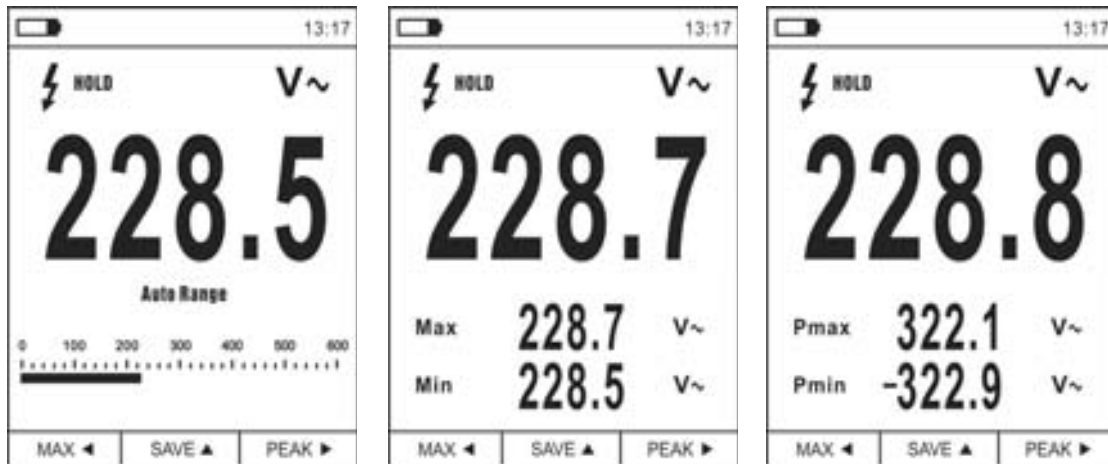

Fig. 4: Description of the symbols shown on the display

Symbol	Description
	Indication of battery charge level
13:17	Indication of the system's current time
HOLD	Indication of active Data HOLD function
V~	Indication of currently selected function
228.5	Indication of measured value
Auto Range	Indication of active Autorange function
Manual Range	Indication of active Manual Range function
	Indication of presence of high voltage
	Indication of analogue bargraph
Max	Indication of maximum value of measured quantity
Min	Indication of minimum value of measured quantity
Pmax	Indication of maximum peak value of measured quantity
Pmin	Indication of minimum peak value of measured quantity
MAX ◀	Activation of MAX/MIN with arrow key ◀
REL ▲	Activation of REL function with arrow key ▲
PEAK ▶	Activation of Pmax/Pmin with arrow key ▶
SAVE ▲	Activation of image storage with arrow key ▲
	Activation of duty cycle test

4.3.2. Description of the display, Thermal camera section (ECLIPSE)

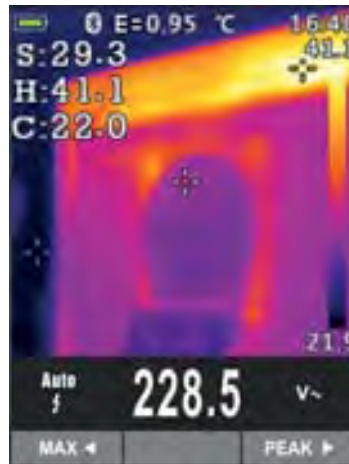

Fig. 5: Description of the symbols shown on the display

Symbol	Description
E=0.95	Set value of object emissivity (see § 4.3.10)
°C	Indication of the temperature measuring unit
S	Indication of the temperature associated with the central steady cursor
H	Indication of the temperature of the hottest spot (Hot) of the image
C	Indication of the temperature of the coldest spot (Cold) of the image
21.9, 41.1	Indication of temperature levels of the IR image
Palette	Indication of color palette (see § 4.3.10)
	Indication of active Bluetooth connection (see § 5.15)

4.3.3. AC+DC current and voltage measurement

The instrument is capable of measuring a possible presence of overlapping alternating components on a generic direct waveform (voltage or current). This can be useful when measuring typical impulsive signals of non-linear loads (e.g. welding machines, electric ovens, etc.).

1. Select positions **VAC+DC**, **LoZAC+DC** or (**standard clamp**)
2. Press key **MODE/VFD** by selecting modes "**V_{AC+DC}**" or "**A_{AC+DC}**" (see Fig. 6).
3. Follow the operating instructions shown in § 5.1 or § 5.9



Fig. 6: Description of AC+DC Voltage and Current measurement

4.3.4. Storage of measurement results



Fig. 7: Saving the value frozen on the display

1. Press key **HOLD/REL** to freeze the result. Message “HOLD” and **SAVE ▲** appears on the display (see Fig. 7 – right side)
2. Press key **▲** to save the value as a BMP image on the instrument's internal memory or press key **HOLD/REL** again to quit the function.
3. Enter the General menu to display the saved result (see § 4.3.10).

4.3.5. Relative measurement

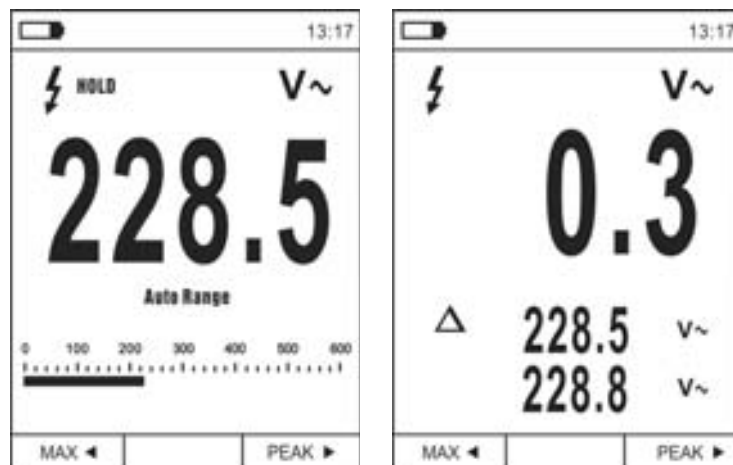

Fig. 8: Relative measurement

1. Long press key **HOLD/REL** to enter relative measurement (see Fig. 8 – right side). The instrument zeroes the display and saves the displayed value as a reference value which subsequent measurements will be referred to. Symbol “Δ” appears on the display. Functions “MAX/MIN” and “PEAK” are not active in this mode.
2. Press key **HOLD/REL** to freeze the result. Message “HOLD” and **SAVE ▲** appears on the display
3. Press key **▲** to save the value as a BMP image on the instrument's internal memory or press key **HOLD/REL** again to go back to function REL.
4. Long press key **HOLD/REL** again or turn the selector switch to quit the function

4.3.6. MIN/MAX and PEAK measurement

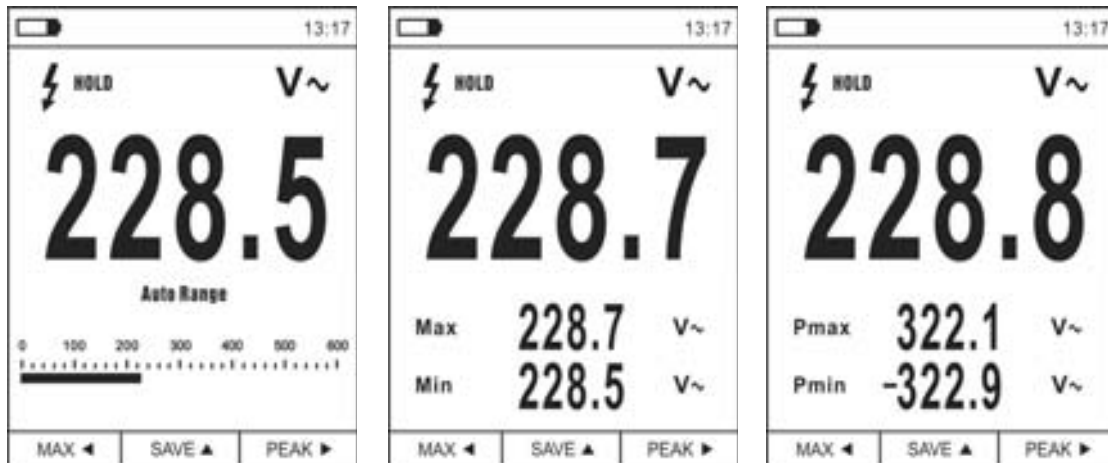

Fig. 9: MIN/MAX and PEAK measurement

1. Press key **MAX** ◀ to enter measurement of MAX and MIN values of the quantity to be measured (see Fig. 9 - central part). The symbols “MAX” and “MIN” appear on the display.
2. The values are automatically updated by the instrument whenever the currently displayed values are exceeded (higher for MAX value, lower for MIN value).
3. Press key **HOLD/REL** to freeze the result. Message “HOLD” and **SAVE** ▲ appears on the display
4. Press key ▲ to save the value as a BMP image on the instrument’s internal memory or press key **HOLD/REL** again to go back to function MAX/MIN
5. Press key **MAX** ◀ again or turn the selector switch to quit the function.
6. Press key **PEAK** ▶ to enter measurement of Peak values of the quantity to be measured (see Fig. 9 – right side). Symbols “Pmax” and “Pmin” appear on the display and values are updated in the same way as for the MAX/MIN function.
7. Press key **HOLD/REL** to freeze the result. Message “HOLD” and **SAVE** ▲ appears on the display
8. Press key ▲ to save the value as a BMP image on the instrument’s internal memory or press key **HOLD/REL** again to go back to the PEAK function.
9. Press key **PEAK** ▶ again or turn the selector switch to quit the function.

4.3.7. Detection of AC voltage without contact



CAUTION

- Firstly use the NCV sensor on a known AC source in order to verify its proper operation.
- The thickness of the cable’s insulating sheath and the distance from the source may influence the operation.

1. Switch on the instrument in any position of the selector switch
2. Take the instrument near an AC source and look for the red LED on the top to turn on (see Fig. 1 – part 3); this indicates that the instrument has detected the source's presence

4.3.8. Measurement of AC, AC+DC Voltage with low impedance (LoZ)

This mode permits to perform the AC/DC voltage measurement with a low input impedance in way to avoid the wrong readings due to stray voltage in capacitive coupled.

1. Select the position **LoZAC+DC**
2. Press key **MODE/VFD** by selecting modes “V \sim ” or “V \approx ” (see Fig. 10)
3. Press the **MODE/VFD** key and select the models
4. Follow the operating instructions shown in § 5.1

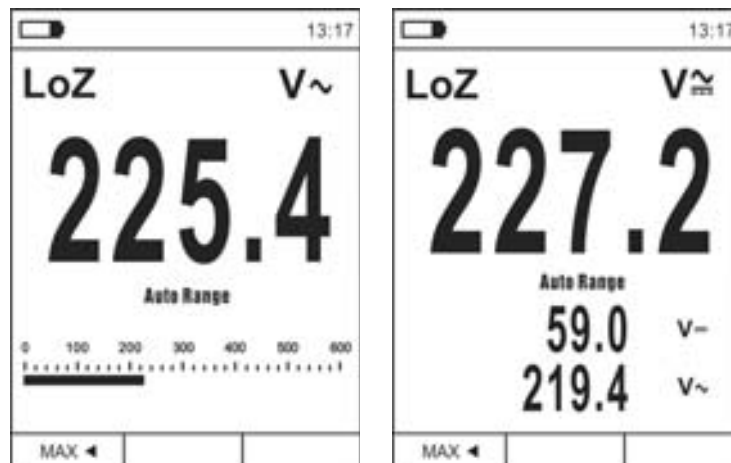

Fig. 10: Description of LoZ voltage measurement

4.3.9. Measurement of Voltage or Current on VFD devices

This mode permits to perform AC voltage or current evaluation downstream to VFD = Variable Frequency Drivers devices.

1. Select the position **VAC+DC \approx** or **60A \approx , 600A \approx , 1000A \approx**
2. Press key **MODE/VFD** by selecting modes “V \sim ” or “A \sim ”
3. Long press key **MODE/VFD** selecting “VFD” mode (see Fig. 11)
4. Follow the operating instructions shown in § or § 5.9
5. Long press key **MODE/VFD** again or turn the selector switch to quit the function

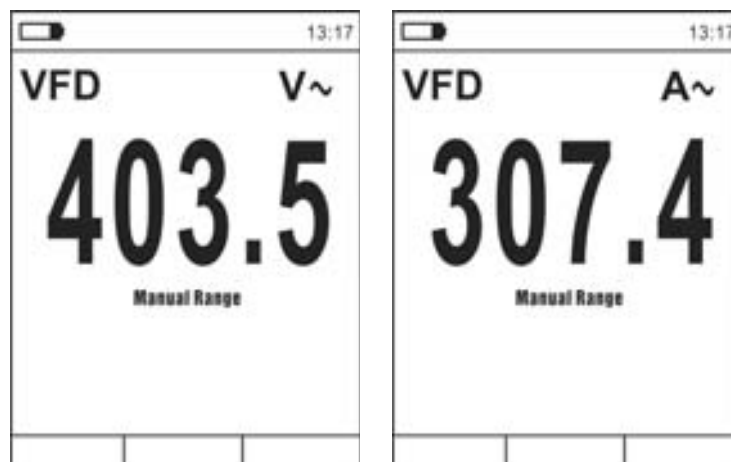

Fig. 11: Description of AC Voltage or Current measurement in VFD mode

4.3.10. General menu of the instrument

1. Press key **MENU** to access the instrument's general menu



Fig. 12: General menu of the instrument (ECLIPSE and HT9025)

2. Use the arrow keys **▲** or **▼** to select menu items and arrow keys **▶**, **◀** to select parameters and enter/quit internal subsections.

Command Palette (ECLIPSE)

3. Select item "Palette" and press key to choose the color palette to be used in Thermal camera mode.
4. Use the arrow key **▶** or key to select among the options: **Iron**, **Rainbow**, **Grey scale**, **Reverse Grey scale**, **Feather**
5. Press the arrow key **◀**, key or key **HOLD/REL** to confirm and quit the general menu.

Command Temp Unit (ECLIPSE)

6. Select item "Temp Unit" and press key or **▶** to enable the selection of the measuring unit of temperature to be used in Thermal camera mode (parameter is highlighted in grey)
7. Use arrow keys **▲** or **▼** to select options: **°C** (Celsius), **°F** (Fahrenheit) or **K** (Kelvin).
8. Press the arrow key **◀**, key or key **HOLD/REL** to confirm and quit the general menu.

Command Measure (ECLIPSE)

9. Select item "Measure" and press key or **▶** to enable activation/deactivation of the cursors associated with the "hottest" or "coldest" spots in the thermographic image (see Fig. 13).



Fig. 13: Measurement Menu

10. Use arrow key ► to select options: **ON** (activation), **OFF** (deactivation).
11. Press the arrow key ◀, key ≡ or key **HOLD/REL** to confirm and quit the general menu.

Command Emissivity (ECLIPSE)

12. Select item “Emissivity” and press keys ≡ or ► to set the value of parameter Emissivity to be used in Thermal Camera mode
13. Use the arrow keys ▲ or ▼ to select the value within range: **0.01 ÷ 1.00**
14. Press the arrow key ◀, key ≡ or key **HOLD/REL** to confirm and quit the general menu.

Command Recording

This command allows setting the parameters and activating the recording of the values of the quantities measured by the instrument in Multimeter mode. For operating instructions, see § 5.13.

Command Language

15. Select item “Language” and press keys ≡ or ► to enable language selection.
16. Use arrow keys ▲ or ▼ to select the language among the available options.



Fig. 14: Language Menu

17. Press the arrow key ◀, key ≡ or key **HOLD/REL** to confirm and quit the general menu.

Command Settings

18. Select item “Settings” and press key ≡ or ► to display system settings. The following screen appears on the display:



Fig. 15: Settings Menu (ECLIPSE and HT9025)

19. Use the arrow keys ▲ or ▼ and keys ≡ or ► to select the following options:
- **Key tone** → activation/deactivation of key tone when pressing function keys.
 - **Bluetooth** → activation/deactivation of Bluetooth connection (see § 5.15).
 - **Laser** → activation/deactivation of laser pointer (ECLIPSE)
 - **Brightness** → setting of the contract level of the display.
 - **Auto power OFF** → deactivation (**OFF**) and activation (**15min, 30min, 60min**) of the instrument's Auto power OFF function
20. Press the arrow key ◀, key ≡ or key **HOLD/REL** to confirm and quit the general menu.

Command Date/Time

21. Select item "Date/Time" and press key ≡ or ► to set system/time. The following screen appears on the display.



Fig. 16: Date/time Menu

22. Use keys ▲ or ▼ and keys ≡ or ► to select/set date/time in the following formats:
- **European** → option **24h** (ON)
 - **American (AM/PM)** → option **24h** (OFF)
23. Press the arrow key ◀, key ≡ or key **HOLD/REL** to confirm and quit the general menu.

Command Memory (recalling and deleting images)

24. Select item "Memory" and press key ≡ or ► to access the instrument's memory in which it is possible to recall and delete saved images. The following screen appears on the display:



Fig. 17: Menu Memory

25. Use the arrow keys ▲ or ▼ and keys ≡ or ► to select option “Recall Photos”. The following screens (corresponding to the last saved image) appear on the display:

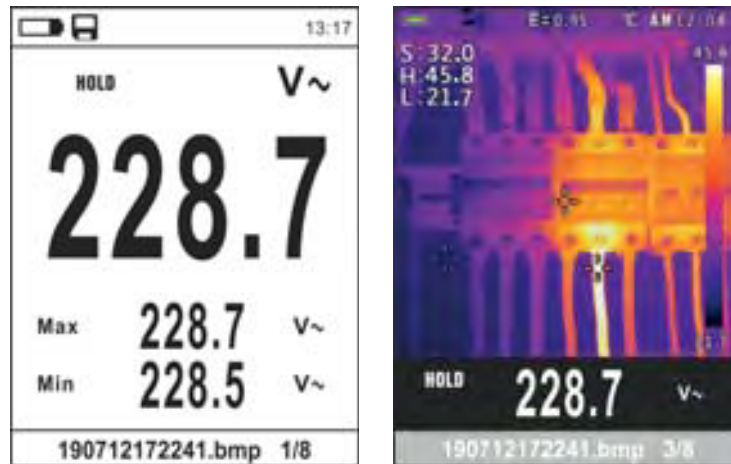

Fig. 18: Recalling images to the display

26. Use the arrow keys ▲ or ▼ to display the desired image among those saved in the instrument's internal memory. The saved image is always in format “YYMMDDHHMMSS.bmp”, which indicates precisely when the image was saved
27. Press key **MODE/VFD** to exit from the function and return in main screen
28. Press key **HOLD/REL** on the recalled image. The screens in Fig. 19 – left side appear on the display

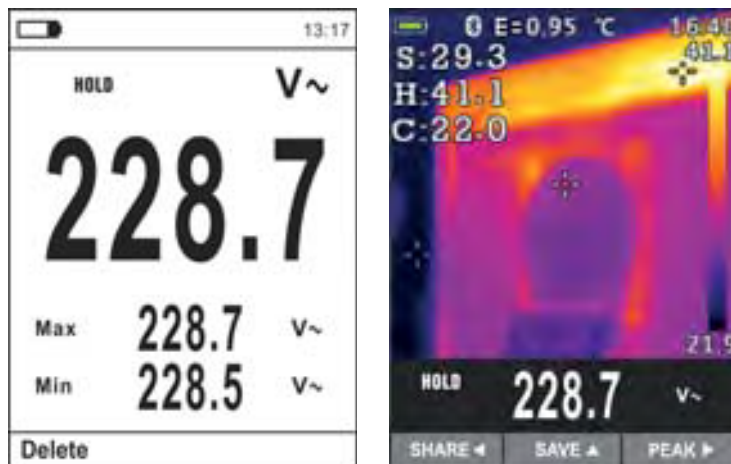

Fig. 19: Deleting and sharing recalled images

29. Press key **MODE/VFD** to delete the recalled image or the key **HOLD/REL** to return in previous screen
30. With image fixed at display use the arrow key ◀ and select the option “Share” (only available for IR image screenshots on ECLIPSE) (see Fig. 19 – right side) to share the image on mobile devices through the APP HTMercury and Bluetooth connection
31. Use the arrow keys ▲ or ▼ and keys ≡ or ► to select option “Delete Photos” (see Fig. 17). The following screen appears on the display:



Fig. 20: Deleting all saved images

32. Use the arrow keys ◀ or ▶ to confirm (Yes) or cancel (No) deletion of all saved images.

33. Press the key ≡ to confirm the operation

Command Information

34. Select item "Information" and press key ≡ or ▶ to display information about the instrument (Hardware and Firmware version)



Fig. 21: Menu Information

35. Press the arrow key ◀, key ≡ or key **HOLD/REL** to confirm and quit the general menu.

Command Factory Set.

36. Select item "Factory Set." and press key ≡ or ▶ to restore the instrument's default settings.



Fig. 22: Default settings reset screen

37. Use the arrow keys ◀ or ▶ to confirm (Yes) or cancel (No) the Reset operation
38. Press the key  to confirm or key **HOLD/REL** to quit the general menu
39. **The operation does not delete the data saved in the instrument's internal memory**

5. OPERATING INSTRUCTIONS

5.1. DC VOLTAGE MEASUREMENT



CAUTION

- The maximum input DC voltage is 1500V. Do not measure voltages exceeding the limits given in this manual. Exceeding voltage limits could result in electrical shocks to the user and damage to the instrument
- **The CAT III 1000V mark on test leads guarantees a safe measurement of voltage up to 1500V**

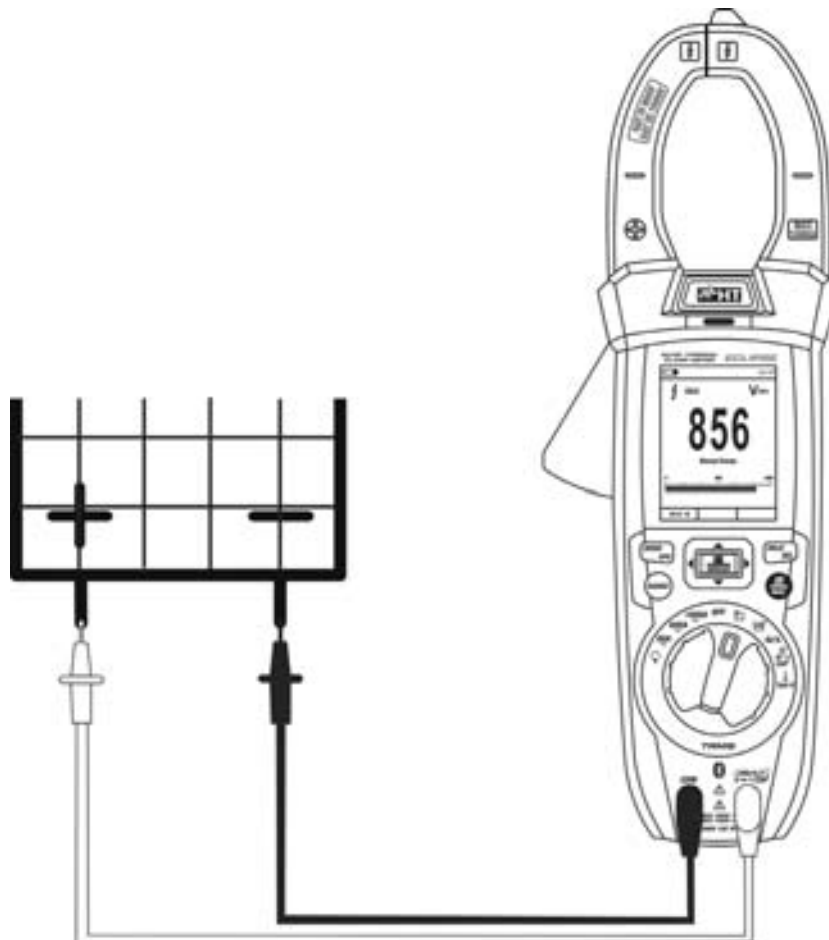

Fig. 23: Use of the instrument for DC, AC+DC voltage measurement

1. Select position **VAC+DC**
2. Press key **MODE/VFD** to select measurement "mV
3. Insert the red cable into input terminal and the black cable into input terminal **COM**
4. Position the red lead and the black lead respectively in the spots with positive and negative potential of the circuit to be measured (see Fig. 23). The display shows the value of voltage.
5. If the display shows message "OL", select a higher range.
6. When symbol "-" appears on the instrument's display, it means that voltage has the opposite direction with respect to the connection in Fig. 23.
7. To use the HOLD and RANGE functions, see § 4.2
8. To use the internal functions see § 4.3
9. To save the measured result, see § 4.3.4

5.2. AC, AC+DC, VFD VOLTAGE MEASUREMENT

CAUTION



The maximum input AC voltage is 1000V. Do not measure voltages exceeding the limits given in this manual. Exceeding voltage limits could result in electrical shocks to the user and damage to the instrument.

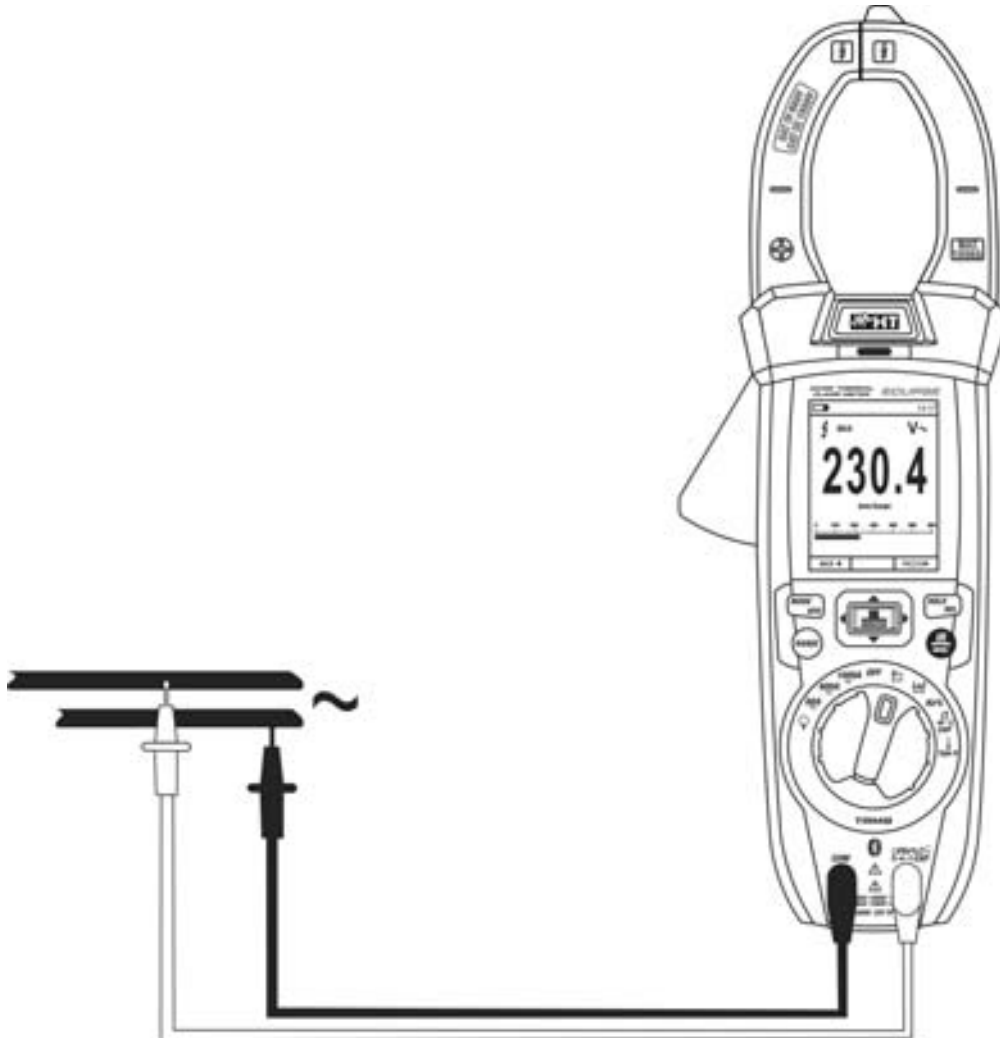

Fig. 24: Use of the instrument for AC, AC+DC, VFD voltage measurement

1. Select position **VAC+DC** . Check for the presence of an AC source (see § 4.3.7).
2. Press key **MODE/VFD** to select measurement “V~”
3. Insert the red cable into input terminal and the black cable into input terminal **COM**.
4. Position the red lead and the black lead respectively in the spots of the circuit to be measured (see Fig. 24). The display shows the value of voltage.
5. If the display shows message “OL”, select a higher range.
6. Press key **MODE/VFD** to select measurements “Hz” or “%” in order to display the values of frequency and duty cycle of input voltage. The bargraph is not active in these functions.
7. To use the HOLD and RANGE functions, see § 4.2
8. For the AC+DC, VFD measurement and the use the internal functions, see § 4.3
9. To save the measured result, see § 4.3.4

5.3. LOZAC, LOZAC+DC VOLTAGE MEASUREMENT

CAUTION



The maximum input AC voltage is 1000V. Do not measure voltages exceeding the limits given in this manual. Exceeding voltage limits could result in electrical shocks to the user and damage to the instrument.

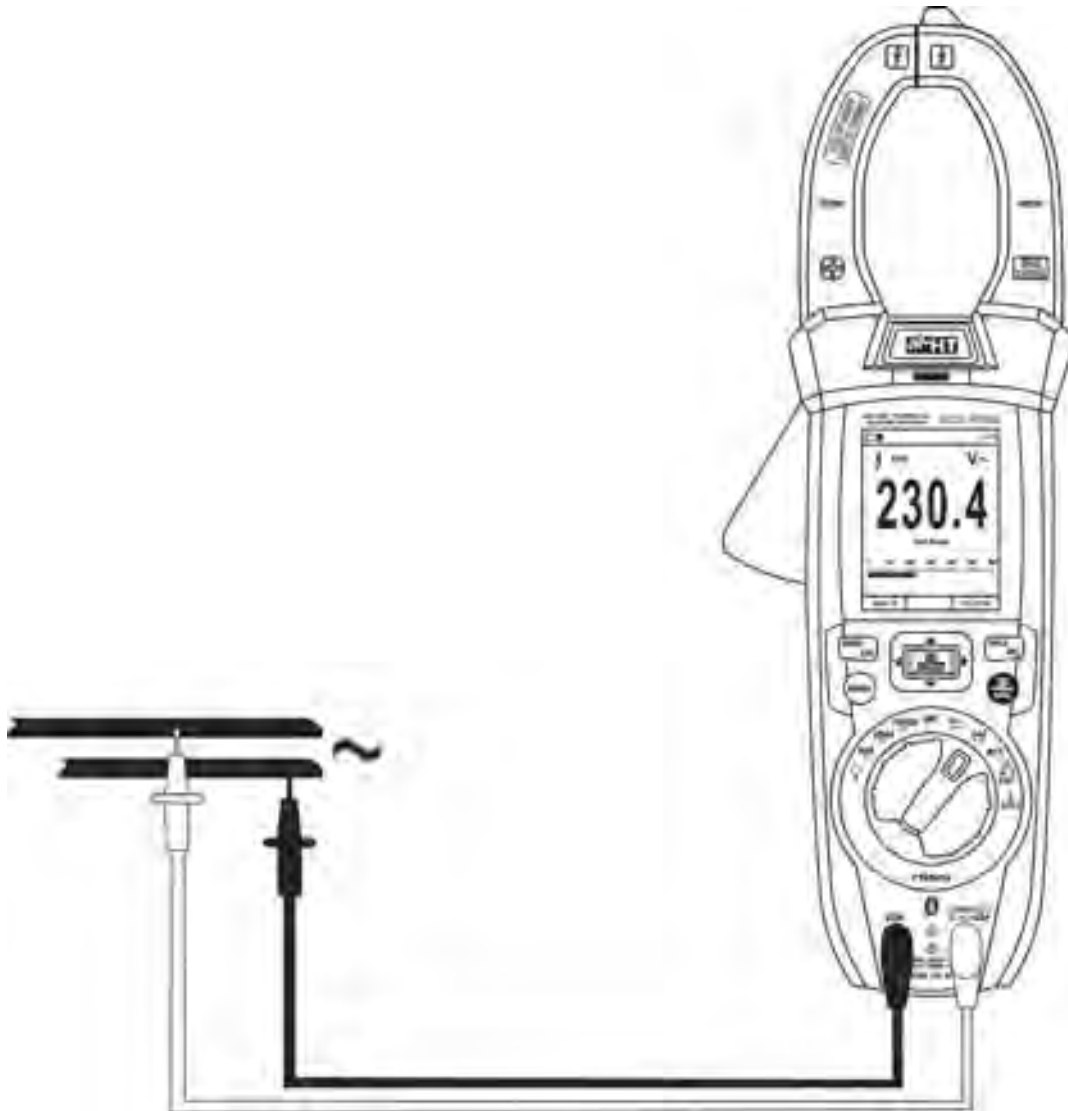

Fig. 25: Use of the instrument for LoZAC, LoZAC+DC voltage measurement

1. Select position **LoZVAC+DC** (see § 4.3.8)
2. Press key **MODE/VFD** to select measurement “V \sim ” or V \approx (AC+DC)”
3. Insert the red cable into input terminal **V \sim Hz%CAP Ω ▶▶▶)** and the black cable into input terminal **COM**.
4. Position the red lead and the black lead respectively in the spots of the circuit to be measured (see Fig. 25). The display shows the value of voltage.
5. If the display shows message “**OL**”, select a higher range.
6. To use the HOLD and RANGE functions, see § 4.2
7. For the AC+DC measurement and the use the internal functions, see § 4.3
8. To save the measured result, see § 4.3.4

5.4. FREQUENCY AND DUTY CYCLE MEASUREMENT

CAUTION



The maximum input AC voltage is 1000V. Do not measure voltages exceeding the limits given in this manual. Exceeding voltage limits could result in electrical shocks to the user and damage to the instrument.

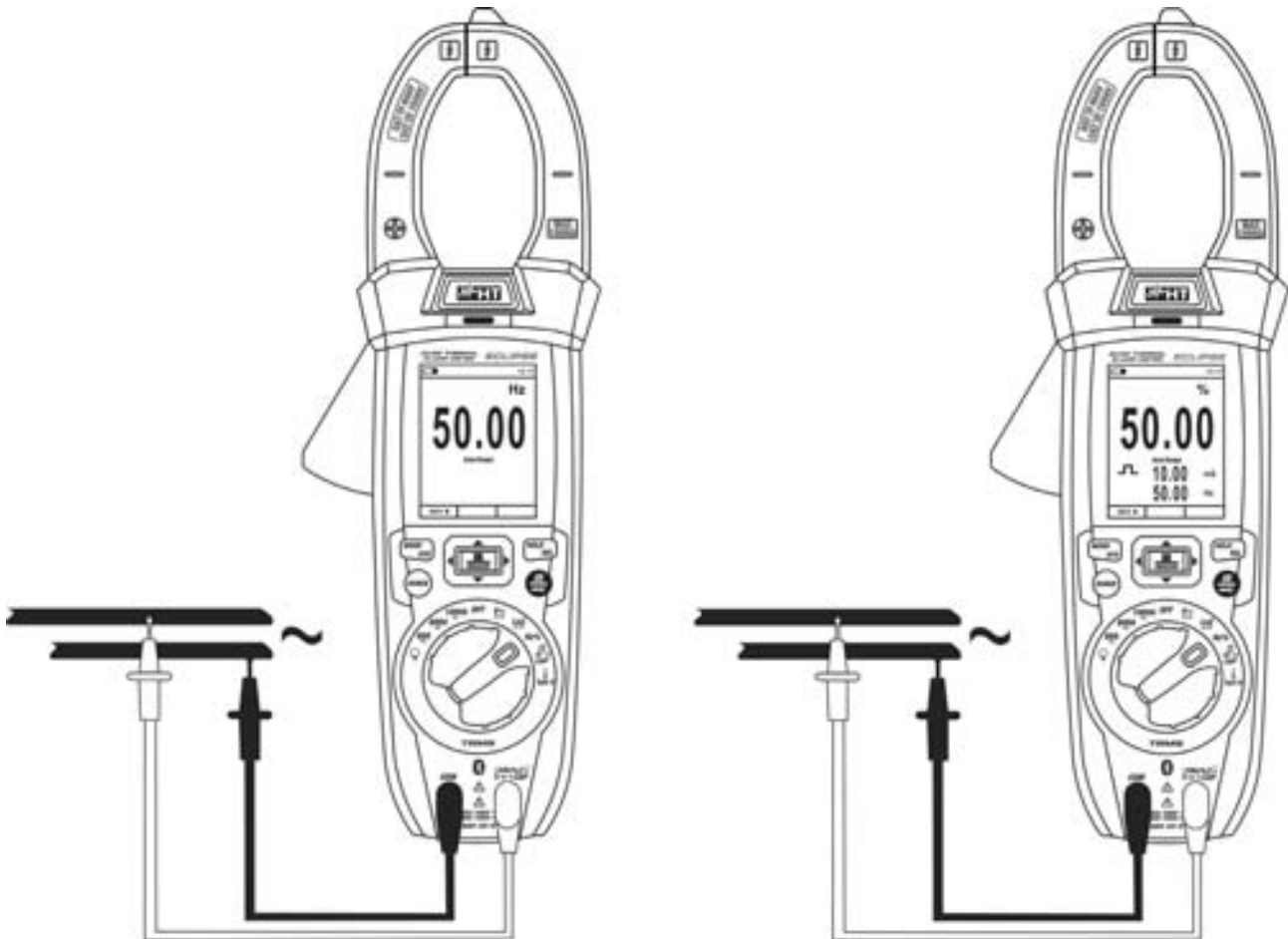



Fig. 26: Use of the instrument for frequency measurement and duty cycle test.

1. Select position **Hz%**.
2. Press key **MODE/VFD** to select measurements “Hz” or “%” in order to display the values of frequency and duty cycle (symbol “” on the display) of input signal.
3. Insert the red cable into input terminal  and the black cable into input terminal **COM**.
4. Position the red lead and the black lead respectively in the spots of the circuit to be measured (see Fig. 26). The value of frequency (Hz) or of duty cycle (%) is shown on the display. The bargraph is not active in these functions.
5. To use the HOLD and RANGE functions, see § 4.2
6. To use the internal functions, see § 4.3
7. To save the measured result, see § 4.3.4

5.5. RESISTANCE MEASUREMENT AND CONTINUITY TEST

CAUTION



Before attempting any resistance measurement, cut off power supply from the circuit to be measured and make sure that all capacitors are discharged, if present.

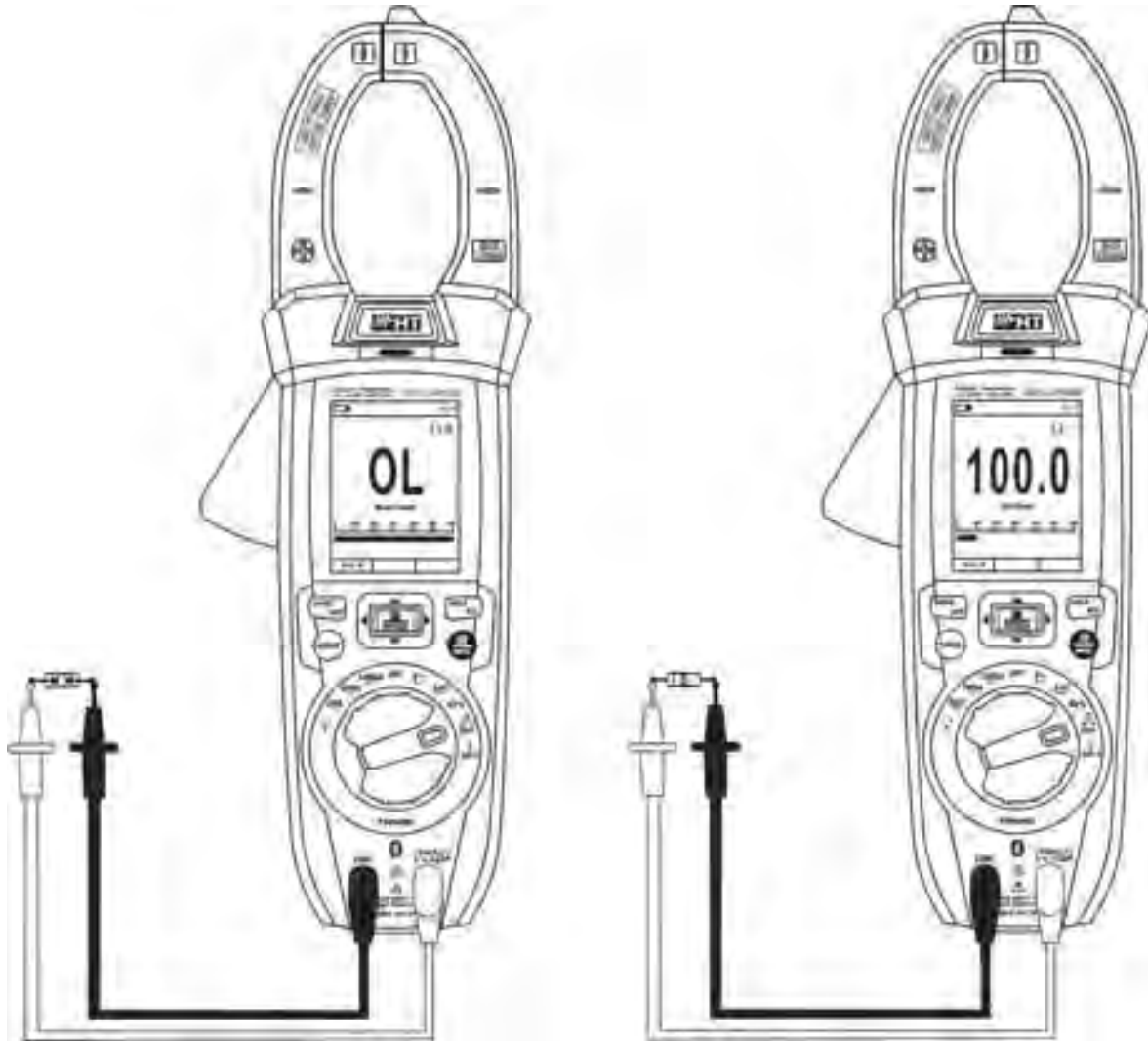

Fig. 27: Use of the instrument for resistance measurement and continuity test

1. Select position $\Omega \rightarrow \text{CAP}$
2. Insert the red cable into input terminal $\text{VHz}\% \text{CAP} \Omega \rightarrow \text{CAP}$ and the black cable into input terminal **COM**.
3. Position the test leads in the desired spots of the circuit to be measured (see Fig. 27). The display shows the value of resistance.
4. If the display shows message “OL”, select a higher range.
5. Press the **MODE/VFD** key to select “ \rightarrow ” measurement, relevant to the continuity test, and position the test leads in the desired spots of the circuit to be measured.
6. The value of resistance (which is only indicative) is displayed in Ω and the instrument sounds if the value of resistance is $< 50. \Omega$
7. To use the HOLD and RANGE functions, see § 4.2
8. To use the internal functions, see § 4.3
9. To save the measured result, see § 4.3.4

5.7. CAPACITANCE MEASUREMENT

CAUTION



Before carrying out capacitance measurements on circuits or capacitors, cut off power supply from the circuit being tested and let all capacitance in it be discharged. When connecting the multimeter and the capacitance to be measured, respect the correct polarity (when required).



Fig. 29: Use of the instrument for Capacitance measurement

1. Select position $\Omega \rightarrow \text{CAP}$
2. Press the **MODE/VFD** key until the symbol "nF" is displayed.
3. Insert the red cable into input terminal $\text{VHz}\% \text{CAP} \Omega \rightarrow \text{CAP}$ and the black cable into input terminal **COM**.
4. Press the **REL/▲** key before carrying out measurement (see § 4.3.5).
5. Position the leads at the ends of the capacitor to be tested, respecting, if necessary, the positive (red cable) and negative (black cable) polarity (see Fig. 29). The value is shown on the display. **According to capacitance, the instrument may take several seconds to display the correct final value.** The bargraph is not active in this function.
6. The message "OL" indicates that the value of capacitance exceeds the maximum measurable value.
7. To use the HOLD and RANGE functions, see § 4.2
8. To use the internal functions, see § 4.3
9. To save the measured result, see § 4.3.4

5.8. TEMPERATURE MEASUREMENT WITH K-TYPE PROBE



CAUTION

Before attempting any temperature measurement, cut off power supply from the circuit to be measured and make sure that all capacitors are discharged, if present.



Fig. 30: Use of the instrument for Temperature measurement

1. Select position **TypeK**.
2. Press the **MODE/VFD** key until the symbol “°C” or “°F” is displayed.
3. Insert the provided adapter into input terminals **VHz% CAP Ω → +** (polarity +) and **COM** (polarity -) (see Fig. 30).
4. Connect the provided K-type wire probe or the optional K-type thermocouple (see § 0) to the instrument by means of the adapter, respecting the positive and negative polarity on it. The display shows the value of temperature. The bargraph is not active in this function.
5. The message “**OL**” indicates that the value of temperature exceeds the maximum measurable value.
6. To use the HOLD and RANGE functions, see § 4.2
7. To use the internal functions, see § 4.3
8. To save the measured result, see § 4.3.4

5.9. DC CURRENT MEASUREMENT

CAUTION



Make sure that all the test leads are disconnected from the meter terminals for current measurement



Fig. 31: Use of the instrument for DC current measurement

1. Select position **60A $\overline{\sim}$** , **600A $\overline{\sim}$** o **1000A $\overline{\sim}$**
2. Press key **MODE/VFD** to select measurement "**A $\overline{\sim}$** "
3. Long press key **HOLD/REL** to perform the zeroing of residual magnetization current (see § 4.3.5)
4. Put the conductor to be tested inside to the center of clamp jaw (see Fig. 31) in order to perform accurated measurements in the direction from positive pole "+" (see Fig. 1 – part 2) to the negative pole "-" (see Fig. 2 – part 1). Consider the notches on jaws as reference (see Fig. 3)
5. The display shows the value of DC current.
6. If the display shows the message "**OL**", the maximum measurable value has been reached.
7. When symbol "-" appears on the instrument's display, it means that current has the opposite direction with respect to the connection in Fig. 31
8. To use the HOLD function, see § 4.2
9. To use the internal functions, see § 4.3.3
10. To save the measured result, see § 4.3.4

5.10. AC CURRENT MEASUREMENT
CAUTION

Make sure that all the test leads are disconnected from the meter terminals for current measurement.

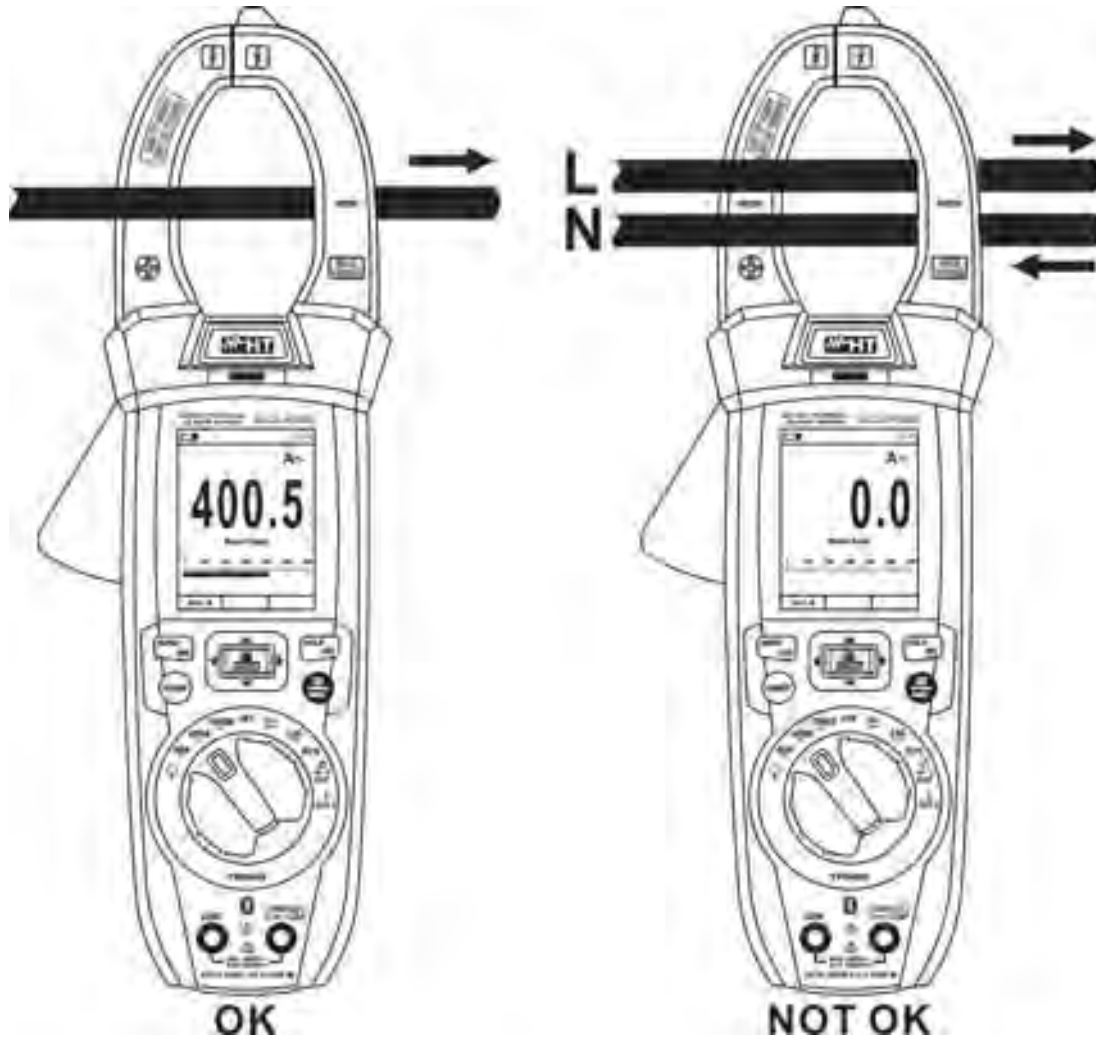

Fig. 32: Use of the instrument for AC current measurement

1. Select positions **60A \sim** , **600A \sim** or **1000A \sim**
2. Press the **MODE/VFD** key to select “A \sim ” measurement
3. Put the conductor to be tested inside to the center of clamp jaw (see Fig. 32) in order to perform accurated measurements. Consider the notches on jaws as reference (see Fig. 3)
4. The display shows the value of current.
5. If the display shows the message “**OL**”, the maximum measurable value has been reached.
6. To use the HOLD function, see § 4.2
7. To use the internal functions, see § 4.3
8. To save the measured result, see § 4.3.4

5.11. INRUSH CURRENT MEASUREMENT

CAUTION



Make sure that all the test leads are disconnected from the meter terminals for current measurement.

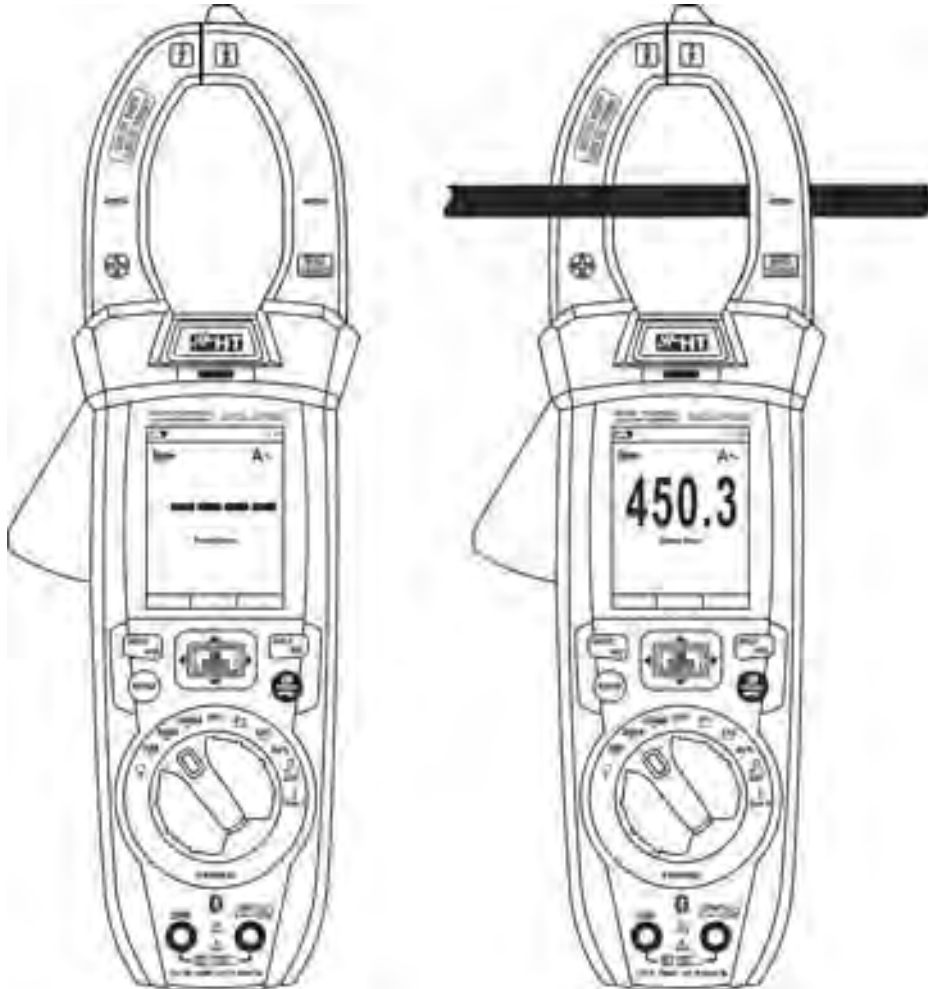

Fig. 33: Use of the instrument for AC Inrush current measurement

1. Select positions **60A \sim** , **600A \sim** or **1000A \sim**
2. Press the **MODE/VFD** key to select “A \sim ” measurement
3. Long press the key **INRUSH** to activate the “INRUSH” function. The “ \sim ” and “- - -” symbols appears at display (see Fig. 33 – left side)
4. Put the conductor to be tested inside to the center of clamp jaw (see Fig. 33 – right side) in order to perform accurated measurements. Consider the notches on jaws as reference (see Fig. 3)
5. The display shows the value of inrush current.
6. If the display shows the message “OL”, the maximum measurable value has been reached.
7. To use the HOLD function, see § 4.2
8. To use the internal functions, see § 4.3
9. To save the measured result, see § 4.3.4

5.12. MEASUREMENT OF DC, AC, AC+DC CURRENT WITH CLAMP TRANSDUCERS
CAUTION

- Maximum measurable current in this function is 3000A AC or 1000A DC. Do not measure currents exceeding the limits given in this manual.
- The instrument carries out the measurement both with flexible clamp transducer F3000U (AC only) and with other **standard** clamp transducers in the HT family. With transducers having an Hypertac output connector, the optional adapter NOCANBA is necessary to obtain the connection.

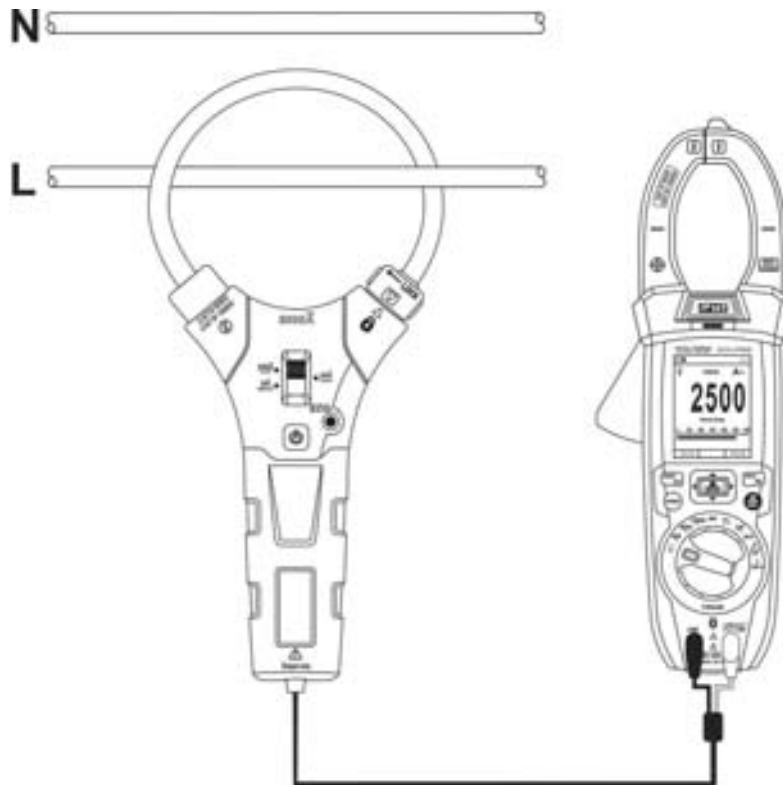



Fig. 34: Use of the instrument for AC/DC current measurement with clamp transducer

1. Select the position.
2. Press and hold (>2s) key **MODE/VFD** to select clamp type between the options “” (standard clamp) or “” (flexible clamp F3000U).
3. Press key **MODE/VFD** to select the type of measurement “DC”, “AC” or “AC+DC” (only for standard clamps).
4. Press key **RANGE** to select on the instrument the same range set on the clamp, among the options: **1000mA**, **10A**, **30A**, **40A**, **100A**, **300A**, **400A**, **1000A**, **3000A**. This value is shown in the top part of the display in the middle.
5. Insert the red cable into input terminal **VHz%** **CAPΩ** **▶** **)))** and the black cable into input terminal **COM**. For standard transducers (see § 8) with Hypertac connector, use optional adapter NOCANBA. For information on the use of clap transducers, please refer to the relevant user manual.
6. Insert the cable into the jaws (see Fig. 34). The display shows the value of current.
7. If the display shows the message “**OL**”, the maximum measurable value has been reached.
8. To use the HOLD function, see § 4.2
9. For AC+DC measurement, see § 4.3.3. To use the internal functions, see § 4.3
10. To save the measured result, see § 4.3.4

5.13. DATA LOGGER FUNCTION

1. Switch on the instrument by turning the rotary switch to the desired position.

Setting of the sampling interval

2. Press key **MENU** , select item "Recording" and press key . The screen in Fig. 35 – left side appears on the display.

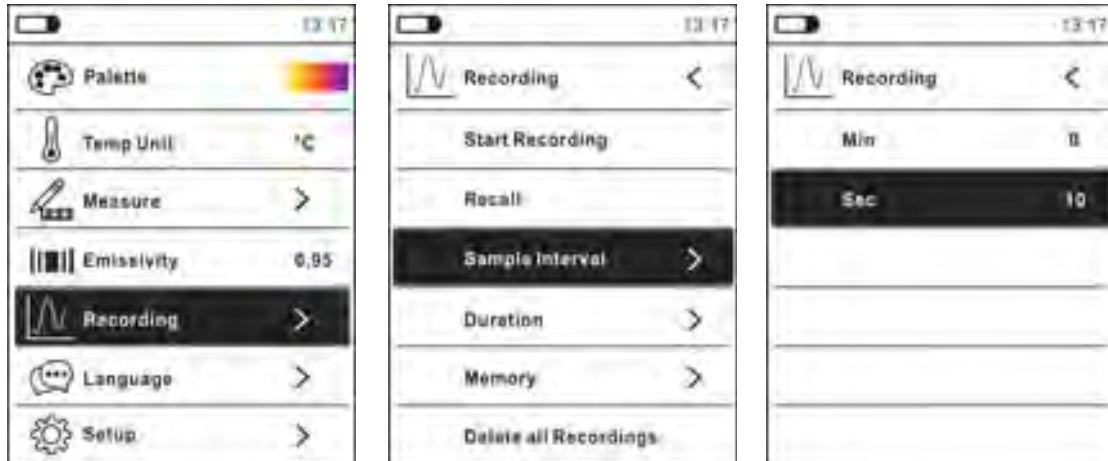









Fig. 35: Data logger function – Setting of the sampling interval

3. Select item "Sample Interval" (see Fig. 35 – middle) and press key  to select the sampling interval for recording. The screen in Fig. 35 – right side appears on the display.
4. Use the arrow keys  or  to select items "Min" or "Sec" and press key  to enter setting mode. The value shown becomes black.
5. Use the arrow keys  or  to set the values within range: **0 ÷ 59sec** and **0 ÷ 15min**
6. Press key  to confirm. The values set become white.
7. Press key  to go back to the previous screen.

Setting recording duration







8. Select item "Duration" (see Fig. 36 – left side) and press key . The screen in Fig. 36 – right side appears on the display.



Fig. 36: Data logger function – Setting of recording duration

9. Use the arrow keys  or  to select items "Hour", "Min" or "Sec" and press key  to enter setting mode. The value shown becomes black.
10. Use the arrow keys  or  to set the values within range: **0 ÷ 10hours**, **0 ÷ 59min** and **0 ÷ 59sec**

11. Press key to confirm. The values set become white.
12. Press key to go back to the previous screen.

Starting and stopping recording

13. Select item “Start Recording” (see Fig. 37 – left side) and press key . The screen in Fig. 37 – middle, in which the date and time of recording start, the remaining time and the number of samples taken in real time are indicated, appears on the display. Message “Recording” appears in the top part of the display, to indicate the ongoing process.



Fig. 37: Data logger function – Starting and stopping recording

14. Press key (**STOP**) to stop recording at any time or wait for the operation to be completed.
15. Once the operation is completed, the screen in Fig. 37 – right side appears on the display. Press key (**SAVE**) to save recording in the instrument’s internal memory, or key (**CLOSE**).

Recalling, displaying and deleting recorded data

16. Select item “Recall” (see Fig. 38 – left side) and press key . The screen in Fig. 38 – right side appears on the display.

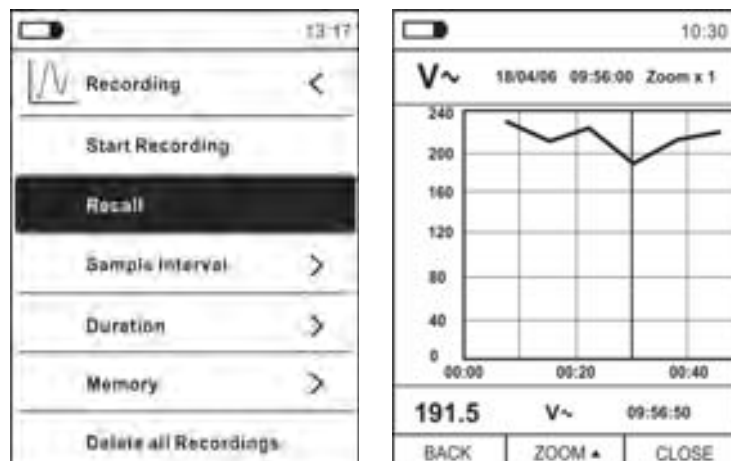

Fig. 38: Data logger function – Recalling recorded data to the display

17. Press key **MODE (TREND)** to display the graph of the recording and the relevant trend over time (Trend). The screen in Fig. 39 – left side appears on the display.

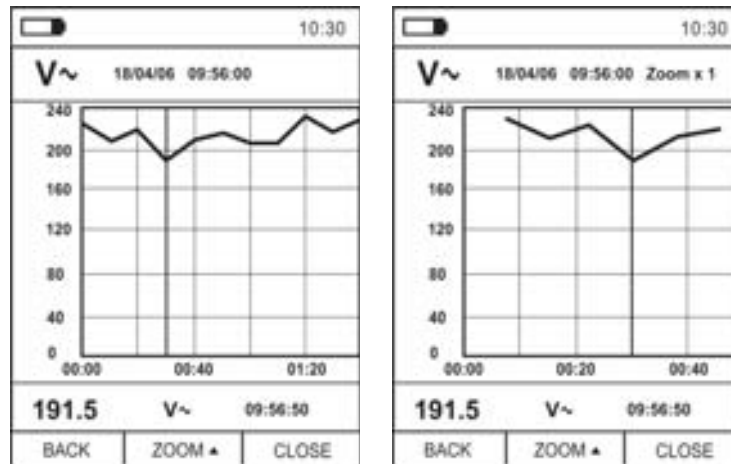

Fig. 39: Data logger function – Display of recording graph

18. Use arrow keys ◀ or ▶ to move the cursor on the graph, looking at the value of the sampled data and at the relevant sampling moment at the bottom of the display.
19. Press key ▲ (**ZOOM**) to activate (if available) the Zoom of the values on the graph (see Fig. 39 – right side) in order to increase resolution. The indication “Zoom xY” in which Y = max zoom dimension appears at the top of the display. You can zoom X1 for at least 10 measuring points, X2 for at least 20 measuring points, X3 for at least 40 measuring points and so on, for maximum 6 zooming operations.
20. Press key **MODE/VFD (TREND)** to go back to the previous screen, or key **HOLD/REL** to go back to the normal measuring screen.
21. Press key ▲ (**CANC.**) to delete the recalled recording. The following screen and the message “Delete recording?” appears on the display.



Fig. 40: Data logger function – Deleting recorded data

22. Press key ▲ (**CANC.**) again to confirm operation or key **HOLD/REL** to go back to the normal measuring screen.

Content of the memory and deletion of all recorded data

23. Select item “Memory” (see Fig. 41 – left side) and press key ►. The screen in Fig. 41 – right side appears on the display.



Fig. 41: Data logger function – Content of the memory

24. Parameter “Num. Recordings” indicates how many recordings have been saved in the internal memory. It is possible to save up to a maximum of 16 recordings. Parameter “Free memory” indicates the percentage value of memory still available to save recordings.

25. Press key ◀ to go back to the previous screen.

26. Select item “Delete all recordings” (see Fig. 42 – left side) and press key ≡. The screen in Fig. 42 – right side appears on the display.



Fig. 42: Data logger function – Deleting all recordings

27. Use the arrow keys ◀ or ► and key ≡ to confirm deletion (Yes) or to quit and go back to the previous screen (No).

5.14. USE OF THE INTERNAL THERMAL CAMERA (ECLIPSE)

1. Switch on the instrument in any position of the selector switch.
2. Press key **IR/** to activate the internal thermal camera.
3. Move the protection selector (see Fig. 2 – part 3) and uncover the lens.
4. Press key **≡** to enter the general menu to set the emissivity value of the object to be tested, to activate - if necessary - measuring spots H (hot spot) and C (cold spot) and the laser pointer, as described in §. 4.3.10
5. Frame the object to be tested, whose thermographic image will be displayed (see § 4.3.2) with automatic focusing.
6. In the thermographic image measuring spots H and C are respectively indicated with red and blue cross pointers.

CAUTION



The instrument carries out an automatic autocalibration sequence approx. every 10s (it cannot be disabled). This condition is also carried out during the internal thermal camera's normal operation, in order to eliminate offset errors. The noise produced by the commutation of internal parts is not to be considered as a problem of the instrument.

7. For accurate temperature measurements, make sure the surface of the measured object is always bigger than the surface measurable by the instrument, which is given by the instruments field of view (FOV). ECLIPSE has a field of view of $21^\circ \times 21^\circ$ and a detection vector of 80×80 (6400) pxl, as described in Fig. 43

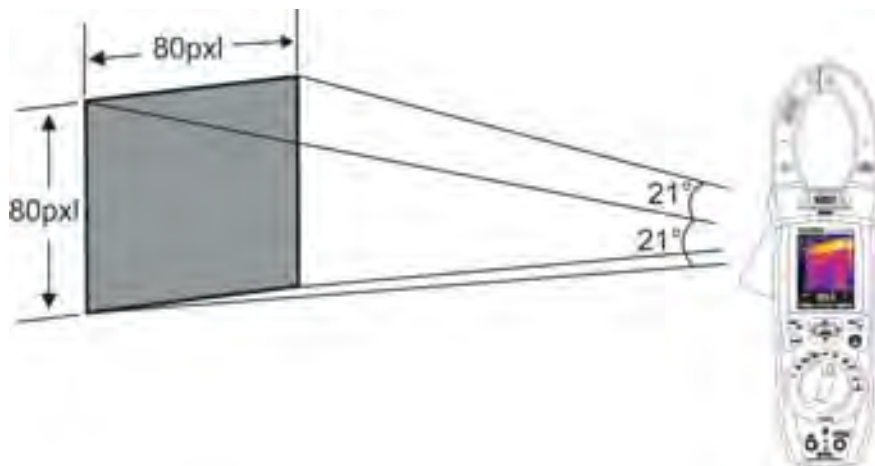

Fig. 43: Representation of the field of view (FOV) of ECLIPSE

8. The representation of the ratio D (distance from the object) / S (surface of the object) for ECLIPSE provided with 7.5mm lens is described below

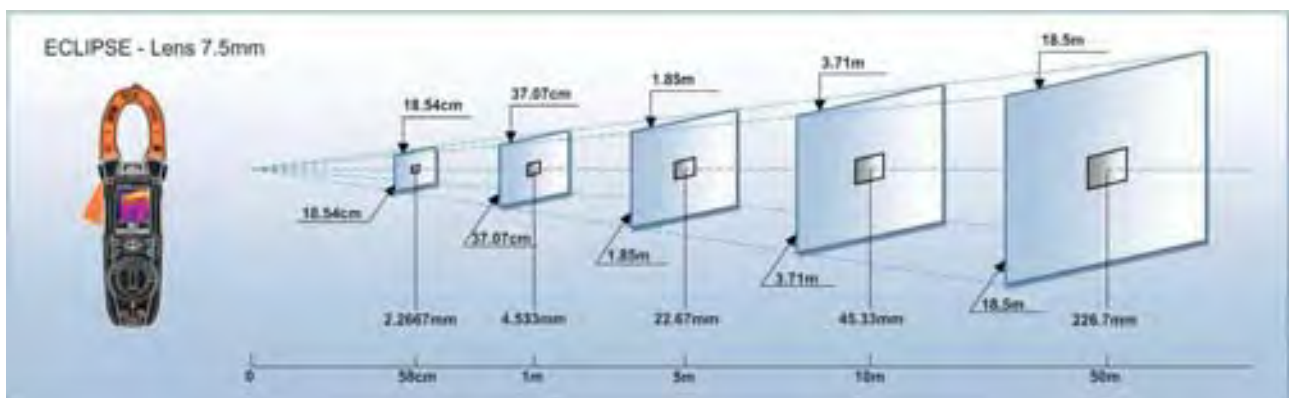

Fig. 44: Representation of the D/S ratio of ECLIPSE

In the representation, it is possible to see how the IFOV (Instant Field Of View = geometrical resolution of the instrument = size of the single pxl of the IR sensor) is equal to 4.53mm at a distance of 1m of the instrument from the object being measured. This means that the instrument is capable of carrying out correct temperature measurements at a distance of 1m on objects with a size not lower than 4,53mm.

9. Press key **HOLD/REL** to freeze the result. Message “HOLD” and **SAVE ▲** key appears on the display (see Fig. 45)

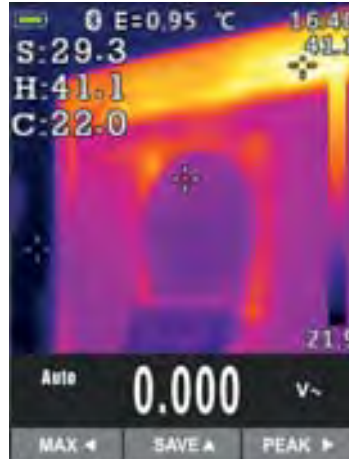

Fig. 45: Saving IR images

10. Press key **▲** to save the value as a BMP image on the instrument's internal memory or press key **HOLD/REL** again to quit the function.
11. Enter the General menu to display the saved result (see Fig. 46 – left side)

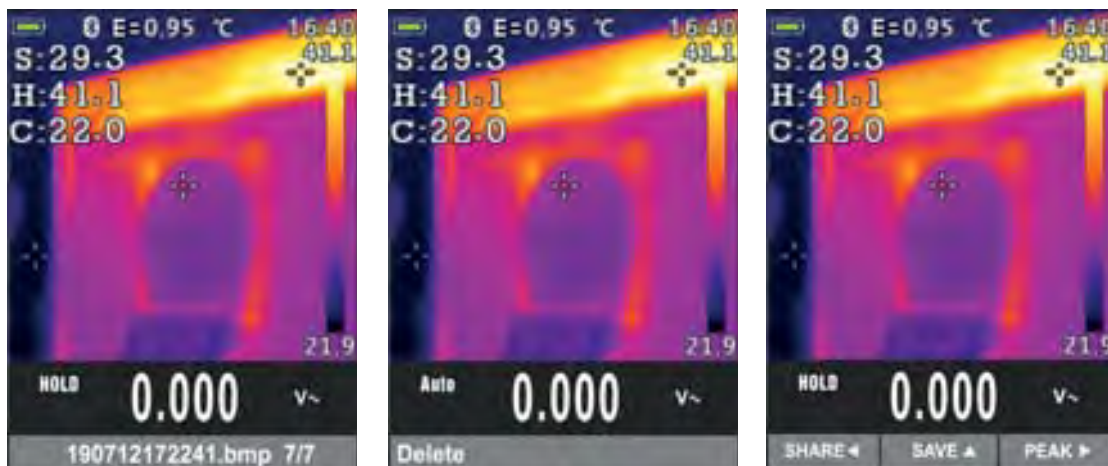

Fig. 46: Recalling and deleting IR images

12. Press key **HOLD/REL** to select the “Delete” option and confirm with key **MOD/VFD** screen
13. Use the arrow keys **◀** or **▶** to select the option “Share” in order to share the image on mobile devices through the APP HTMercury and Bluetooth connection (see § 5.15)

5.15. BLUETOOTH CONNECTION AND USE OF THE APP HTMERCURY

1. Press key /INRUSH, select menu "Setup" and activate the Bluetooth connection on the instrument (see § 4.3.10) as shown in Fig. 47



Fig. 47: Activation of Bluetooth connection

2. Download the APP **HTMercury** free from Android and iOS stores and install it on the mobile device (tablet/smartphone).
3. Activate Bluetooth connection on the mobile device and launch the APP HTMercury.
4. Search for the instrument in the APP (see Fig. 48 – left side).



Fig. 48: Communication with the APP HTMercury

5. The instrument's input signal is displayed in real time on the mobile device (see Fig. 48 – right side) and it is possible to save screenshots and to activate/deactivate recordings from the internal menus of the APP. it is also possible to save screenshots of thermographic images and insert objects for advanced analyses (see Fig. 49). See the Help on line of APP for details.

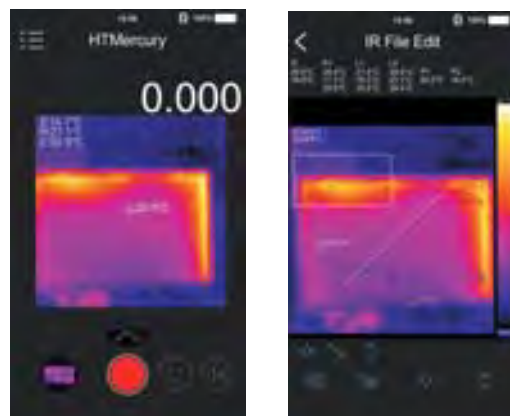

Fig. 49: Applications of the APP HTMercury

6. MAINTENANCE







CAUTION

- Only expert and trained technicians should perform maintenance operations. Before carrying out maintenance operations, disconnect all cables from the input terminals.
- Do not use the instrument in environments with high humidity levels or high temperatures. Do not expose to direct sunlight.
- Always switch off the instrument after use. In case the instrument is not to be used for a long time, remove the battery to avoid liquid leaks that could damage the instrument's internal circuits.

6.1. RECHARGING THE INTERNAL BATTERY

When the LCD displays symbol , it is necessary to recharge the internal battery.

1. Position the rotary switch to **OFF** and remove the cables from the input terminals.
2. Turn the fastening screw of the battery compartment cover from position  to position  and remove it (see Fig. 3 – part 2).
3. Remove the rechargeable battery and insert it in the provided recharging base.
4. Insert the power supply in the recharging base.
5. Connect the power supply to the electric mains and to the recharging base. Look for the green “Power” LED and red “Charge” LED to turn on.
6. Carry on the recharging process until the red “Charge” LED turns off.
7. Disconnect the power supply from the electric mains and extract the battery from the recharging base.
8. Insert the battery into the instrument again.
9. Restore the battery compartment cover into place and turn the fastening screw from position  to position .

6.2. CLEANING THE INSTRUMENT

Use a soft and dry cloth to clean the instrument. Never use wet cloths, solvents, water, etc.

6.3. END OF LIFE



WARNING: the symbol on the instrument indicates that the appliance and its accessories must be collected separately and correctly disposed of.

7. TECHNICAL SPECIFICATIONS

Accuracy calculated as [%reading + (num. digits*resolution)] at 18°C ÷ 28°C <75%RH.

DC Voltage

Range	Resolution	Accuracy	Input impedance	Overload protection
600.0mV	0.1mV	±(0.8%rdg + 8dgt)	>10MΩ	1500VDC
6.000V	0.001V	±(0.5%rdg + 5dgt)		
60.00V	0.01V			
600.0V	0.1V	±(0.8%rdg + 5dgt)		
1500V	1V	±(0.8%rdg + 5dgt)		

AC TRMS Voltage

Range	Resolution	Accuracy (*)		Overload protection
		(50Hz÷60Hz)	(61Hz÷1kHz)	
6.000V	0.001V	±(1.2%reading + 5digits)	±(2.5%reading+5digits)	1000VDC/ACrms
60.00V	0.01V			
600.0V	0.1V			
1.000V	1V			

(*) Accuracy specified from 10% to 100% of the measuring range, Input impedance: > 9MΩ, sinusoidal waveform

Accuracy of PEAK function: ±(10%reading), Response time of PEAK function: 1ms

For a non-sinusoidal waveform, accuracy is: ±(10.0%rdg + 20digits)

Integrated NCV sensor for AC voltage detection: LED on for phase-earth voltage in range 100V - 1000V, 50/60Hz.

AC+ DC TRMS Voltage

Range	Resolution	Accuracy (50Hz÷1kHz)	Input impedance	Overload protection
6.000V	0.001V	±(2.5%reading+20digits)	>10MΩ	1000VDC/ACrms
60.00V	0.01V			
600.0V	0.1V			
1.000V	1V			

AC TRMS Voltage with low impedance (LoZ)

Range	Resolution	Accuracy (*) (50Hz÷1kHz)	Input impedance	Overload protection
6.000V	0.001V	±(3.0%readings+20dgt)	300kΩ	1000VDC/ACrms
60.00V	0.01V			
600.0V	0.1V			
1000V	1V			

(*) Accuracy specified from 10% to 100% of the measuring range sinusoidal waveform

For a non-sinusoidal waveform, accuracy is: ±(10.0%rdg + 20digits)

AC+DC TRMS Voltage with low impedance (LoZ)

Range	Resolution	Accuracy (50Hz÷1kHz)	Input impedance	Overload protection
6.000V	0.001V	±(3.5%readings+40dgt)	<300kΩ	1000VDC/ACrms
60.00V	0.01V			
600.0V	0.1V			
1000V	1V			

DC Current

Range	Resolution	Accuracy	Overload protection
60.00A	0.01A	$\pm(2.0\% \text{reading} + 8 \text{digits})$	1000VDC/ACrms
600.0A	0.1A		
1000A	1A		

AC TRMS Current / INRUSH current

Range	Resolution	Accuracy (*) (50Hz÷60Hz)	Overload protection
60.00A	0.01A	$\pm(2.5\% \text{reading} + 5 \text{digits})$	1000VDC/ACrms
600.0A	0.1A		
1000A	1A		

(*) Accuracy specified from 10% to 100% of the measuring range, Input impedance: > 9M Ω , sinusoidal waveform
Response time INRUSH function: 100ms

DC Current by means of standard clamp transducers

Range	Output ratio	Resolution	Accuracy (*)	Overload protection	
1000mA	1000mV/1000mA	1mA	$\pm(0.8\% \text{reading} + 5 \text{digits})$	1000VDC/ACrms	
10A	100mV/1A	0.01A			
40A (**)	10mV/1A	0.01A			$\pm(1.8\% \text{reading} + 5 \text{digits})$
100A	10mV/1A	0.1A			$\pm(0.8\% \text{reading} + 5 \text{digits})$
400A (**)	1mV/1A	0.1A			$\pm(1.8\% \text{reading} + 5 \text{digits})$
1000A	1mV/1A	1A			$\pm(0.8\% \text{reading} + 5 \text{digits})$

(*) Accuracy referred to the sole instrument without transducer; (**) with clamp transducer HT4006
For a non-sinusoidal waveform, accuracy is: $\pm(10.0\% \text{rdg} + 10 \text{digits})$

AC TRMS, AC+DC TRMS Current with standard clamp transducers

Range	Output ratio	Resolution	Accuracy (*)		Overload protection	
			(50Hz÷60Hz)	(61Hz÷1kHz)		
1000mA	1V/1mA	1mA	$\pm(0.8\% \text{rdg} + 5 \text{dgt})$	$\pm(2.4\% \text{rdg} + 5 \text{dgt})$	1000VDC/ACrms	
10A	100mV/1A	0.01A				
40A (**)	10mV/1A	0.01A				$\pm(1.8\% \text{rdg} + 5 \text{dgt})$
100A	10mV/1A	0.1A				$\pm(0.8\% \text{rdg} + 5 \text{dgt})$
400A (**)	1mV/1A	0.1A				$\pm(1.8\% \text{rdg} + 5 \text{dgt})$
1000A	1mV/1A	1A				$\pm(0.8\% \text{rdg} + 5 \text{dgt})$

(*) Accuracy referred to the sole instrument without transducer; (**) with clamp transducer HT4006

AC TRMS Current with flexible clamp transducer (F3000U)

Range	Output ratio	Resolution	Accuracy (50Hz÷400Hz) (*)	Overload protection
30A	100mV/1A	0.01A	$\pm(3.0\% \text{reading} + 5 \text{digits})$	1000VDC/ACrms
300A	10mV/1A	0.1A		
3000A	1mV/1A	1A		

(*) Accuracy referred to the sole instrument without transducer ; Accuracy specified from 5% to 100% of the measuring range
Accuracy of PEAK function: $\pm(10\% \text{reading} + 20 \text{dgt})$, Response time of PEAK function: 1ms

Diode test

Function	Test current	Max voltage with open circuit
	<1.5mA	3.3VDC

Frequency (electrical circuits)

Range	Resolution	Accuracy	Overload protection
40.00Hz ÷ 10kHz	0.01Hz ÷ 0,001kHz	±(0.5%reading)	1000VDC/ACrms

Sensitivity: 2Vrms

Frequency (electronic circuits)

Range	Resolution	Accuracy	Overload protection
60.00Hz	0.01Hz	±(0.2%rdg+5digits)	1000VDC/ACrms
600.0Hz	0.1Hz		
6,000kHz	0,001kHz		
60.00kHz	0.01kHz		
600.0kHz	0.1kHz		
6,000MHz	0,001MHz		
10.00MHz	0.01MHz		

Sensitivity: >2Vrms (@ 20% ÷ 80% duty cycle) and f<100kHz; >5Vrms (@ 20% ÷ 80% duty cycle) and f>100kHz

Resistance and Continuity test

Range	Resolution	Accuracy	Buzzer	Overload protection
600.0Ω	0.1Ω	±(1.0%rgd + 10digits)	<50Ω	1000VDC/ACrms
6.000kΩ	0.001kΩ	±(0.8%reading + 5digits)		
60.00kΩ	0.01kΩ			
600.0kΩ	0.1kΩ			
6.000MΩ	0.001MΩ	±(2.5%rgd + 10digits)		
60.00MΩ	0.01MΩ			

Duty Cycle

Range	Resolution	Accuracy
10.0% ÷ 90.0%	0.1%	±(1.2%rdg + 8digits)

Pulse frequency range: 40Hz ÷ 10kHz, Pulse amplitude: ±5V (100μs ÷ 100ms)

Capacitance

Range	Resolution	Accuracy	Overload protection
60.00nF	0.01nF	±(3.0%rdg + 20dgt)	1000VDC/ACrms
600.0nF	0.1nF	±(3.0%rdg + 8dgt)	
6.000μF	0.001μF		
60.00μF	0.01μF		
600.0μF	0.1μF	±(3.5%rdg + 20dgt)	
6000μF	1μF		
60.00mF	0.01mF	±(5.0%rdg + 40dgt)	
100.0mF	0.1mF		

Temperature with K-type probe

Range	Resolution	Accuracy (*)	Overload protection
-40.0°C ÷ 600.0°C	0.1°C	±(1.5%rdg + 3°C)	1000VDC/ACrms
601°C ÷ 1000°C	1°C		
-40.0°F ÷ 600.0°F	0.1°F	±(1.5%rdg+ 5.4°F)	
601°F ÷ 1800°F	1°F		
245.0K ÷ 600.0K	0.1K	±(1.5%rdg+ 3K)	
601K ÷ 1273K	1K		

(*) Instrument accuracy without probe ; Specified accuracy with stable environmental temperature at ±1°C

Infrared temperature (ECLIPSE)

Type of IR sensor	UFPA (80x80pxl, 34 μ m)
Spectrum response	8 \div 14 μ m
Visual range (FOV) / Lens	21°x 21° / 7.5mm
IFOV (@1m)	4.53mrad
Thermal sensitivity / NETD	<0.1°C (@30°C /86°F) / 100mK
Focusing	automatic
Minimum focus distance	0.5m
Image frequency	50Hz
Temperature readings	°C, °F, K
Available color palettes	5 (Iron, Rainbow, Grey, Reverse grey, Feather)
Laser pointer	class 2 according to IEC 60825-1
Built-in illuminator	white-light LED
Emissivity correction	0.01 \div 1.00 in steps of 0.01
Measuring cursors	3 (Fixed, Max Temp., Min Temp.)
Measuring range	-20°C \div 260°C (-4°F \div 500°F)
Accuracy	\pm 3%reading or \pm 3°C (\pm 5.4°F) (environmental temperature 10°C \div 35°C, object temperature >0°C)

General characteristics
Reference standards

Safety:	IEC/EN61010-1
EMC:	IEC/EN61326-1
Insulation:	double insulation
Pollution level:	2
Measurement category:	CAT IV 600V, CAT III 1000V
Max operating altitude:	2000m (6562ft)

Mechanical characteristics

Size (L x W x H):	280 x 100 x 50mm (11 x 4 x 2in)
Weight (battery included):	505g (18 ounces)
Mechanical protection:	IP40
Max conductor size:	40mm (2in)

Power supply

Battery type:	1x7.4V rechargeable Li-ION battery, 1200mAh
Battery charger power supply:	100/240VAC, 50/60Hz, 12VDC, 2A
Low battery indication:	symbol "  " on the display
Recharging time:	approx. 2 hours
Battery duration:	approx. 8 hours (Bluetooth deactivated) approx. 7 hours (active Bluetooth)
Auto Power Off (disabled):	after 15-60min minutes' idling

Display

Conversion:	TRMS
Characteristics:	color TFT, 6000 dots with bargraph
Sampling frequency:	3 times/s

External memory
Internal memory

max 128 snapshots in BMP format
 max 16 recordings or 34 hours (SI=1s),
 sampling interval: 1s \div 15min
 duration single recording: max 10 hours

Bluetooth connection	type BLE 4.0
compatible mobile devices	Android 4.4 or higher system, iPhone 4 or higher
Environmental conditions for use	
Reference temperature:	18°C ÷ 28°C (64°F ÷ 82°F)
Operating temperature:	5°C ÷ 40°C (41°F ÷ 104°F)
Allowable relative humidity:	<80%RH
Storage temperature:	-20°C ÷ 60°C (-4°F ÷ 140°F)
Storage humidity:	<80%RH

This instrument satisfies the requirements of Low Voltage Directive 2014/35/EU (LVD) and of EMC Directive 2014/30/EU
This instrument satisfies the requirements of European Directive 2011/65/EU (RoHS) and 2012/19/EU (WEEE)

8. ACCESSORIES

Accessories provided

- | | |
|---|--------------|
| • Pair of test leads | |
| • Adapter + K-type wire probe | |
| • Li-ION rechargeable battery (HT9025) | Code BATEC95 |
| • Li-ION rechargeable battery, 2 pieces (ECLIPSE) | Code BATEC95 |
| • Multiplug power supply + recharging base | Code A0EC95 |
| • Carrying bag | Code B0EC95 |
| • ISO9000 calibration certificate | |
| • User manuals | |

Optional accessories

- | | |
|---|--------------|
| • K-type probe for air and gas temperature | Code TK107 |
| • K-type probe for semisolid substance temperature | Code TK108 |
| • K-type probe for liquid substance temperature | Code TK109 |
| • K-type probe for surface temperature | Code TK110 |
| • K-type probe for surface temperature with 90° tip | Code TK111 |
| • Standard clamp transducer DC/AC 40-400A/1V | Code HT4006 |
| • Standard clamp transducer AC 1-100-1000A/1V | Code HT96U |
| • Standard clamp transducer AC 10-100-1000A/1V | Code HT97U |
| • Standard clamp transducer DC 1000A/1V | Code HT98U |
| • Adapter for connection standard clamp with Hypertac connector | Code NOCANBA |

9. ASSISTANCE

9.1. WARRANTY CONDITIONS

This instrument is warranted against any material or manufacturing defect, in compliance with the general sales conditions. During the warranty period, defective parts may be replaced. However, the manufacturer reserves the right to repair or replace the product. Should the instrument be returned to the After-sales Service or to a Dealer, transport will be at the Customer's charge. However, shipment will be agreed in advance. A report will always be enclosed to a shipment, stating the reasons for the product's return. Only use original packaging for shipment. Any damage due to the use of non-original packaging material will be charged to the Customer. The manufacturer declines any responsibility for injury to people or damage to property.

The warranty shall not apply in the following cases:

- Repair and/or replacement of accessories and battery (not covered by warranty).
- Repairs that may become necessary as a consequence of an incorrect use of the instrument or due to its use together with non-compatible appliances.
- Repairs that may become necessary as a consequence of improper packaging.
- Repairs which may become necessary as a consequence of interventions performed by unauthorized personnel.
- Modifications to the instrument performed without the manufacturer's explicit authorization.
- Use not provided for in the instrument's specifications or in the instruction manual.

The content of this manual cannot be reproduced in any form without the manufacturer's authorization.

Our products are patented and our trademarks are registered. The manufacturer reserves the right to make changes in the specifications and prices if this is due to improvements in technology.

9.2. ASSISTANCE

If the instrument does not operate properly, before contacting the After-sales Service, please check the conditions of battery and cables and replace them, if necessary. Should the instrument still operate improperly, check that the product is operated according to the instructions given in this manual. Should the instrument be returned to the After-sales Service or to a Dealer, transport will be at the Customer's charge. However, shipment will be agreed in advance. A report will always be enclosed to a shipment, stating the reasons for the product's return. Only use original packaging for shipment; any damage due to the use of non-original packaging material will be charged to the Customer.